 **TM100** Thermal Mass Flow Meter  
**Instruction Manual**

Document: S-IM-TM100 | Rev B\_PN 110068

---

**GLOBAL SUPPORT LOCATIONS: WE ARE HERE TO HELP!**

For Global Service Centers, go to <http://www.sierrainstruments.com/facilities.html>

**CORPORATE HEADQUARTERS**

5 Harris Court, Building L Monterey, CA 93940

Phone +1 (831) 373-0200 Fax (831) 373-4402

[info@sierrainstruments.com](mailto:info@sierrainstruments.com)

[www.sierrainstruments.com](http://www.sierrainstruments.com)

**EUROPE HEADQUARTERS**

Bijlmansweid 2 1934RE Egmond aan den Hoef

The Netherlands

Phone +31 72 5071400 Fax +31 72 5071401

[sales@sierrainstruments.nl](mailto:sales@sierrainstruments.nl)

**ASIA HEADQUARTERS**

Second Floor Building 5, Senpu Industrial Park

25 Hangdu Road Hangtouw Town

Pu Dong New District, Shanghai, P.R. China

Postal Code 201316

Phone: + 8621 5879 8521 Fax: +8621 5879 8586

**© COPYRIGHT SIERRA INSTRUMENTS 2023**

No part of this publication may be copied or distributed, transmitted, transcribed, stored in a retrieval system, or translated into any human or computer language, in any form or by any means, electronic, mechanical, manual, or otherwise, or disclosed to third parties without the express written permission of Sierra Instruments. The information contained in this manual is subject to change without notice.



**TRADEMARKS**

TM100™, TM-Cal™, Gas-Mix™, FlowTrak™, TM100-View™, and DigiSense™ are trademarks of Sierra Instruments, Inc. Other product and company names listed in this manual are trademarks or trade names of their respective manufacturers.

## Warnings and Cautions

### General Safety Information

We use caution and warning statements throughout this book to draw your attention to important information.

| Symbol Key  |                |   |
|---|----------------|---|
| Symbol  | Symbol Meaning | Description   |
|  | Warning        | This statement appears with information that is important to protect people and equipment from damage. Pay very close attention to all warnings that apply to your application. |
|  | Caution/Note   | This statement appears with information that is important for protecting your equipment's performance. Read and follow all cautions that apply to your application.             |

### WARNING

- **Warning!** Agency approval for hazardous location installations varies between flow meter models. Consult the flow meter nameplate for specific flow meter approvals before any hazardous location installation.
- **Warning!** Hot tapping must be performed by a trained professional. U.S. regulations often require a hot tap permit. The manufacturer of the hot tap equipment and/or the contractor performing the hot tap is responsible for providing proof of such a permit
- **Warning!** All wiring procedures must be performed with the power Off.
- **Warning!** To avoid potential electric shock, follow National Electric Code safety practices or your local code when wiring this unit to a power source and to peripheral devices. Failure to do so could result in injury or death. All AC power connections must be in accordance with published CE directives.
- **Warning!** Before attempting any flow meter repair, verify that the line is de-pressurized.
- **Warning!** Always remove main power before disassembling any part of the mass flow meter.

 **CAUTION**

- **Caution!** Before making adjustments to the TM100, verify the flow meter is not actively monitoring or reporting to any master control system. Adjustments to the electronics will cause direct changes to flow control settings.
- **Caution!** All flow meter connections, isolation valves and fittings for hot tapping must have the same or higher pressure rating as the main pipeline.
- **Caution!** The flow meter electronics and sensor probe have been manufactured and calibrated to operate as a unit. The flow meter will not operate properly if parts are replaced from another meter.
- **Caution!** Printed circuit boards are sensitive to electrostatic discharge. To avoid damaging the board, follow these precautions to minimize the risk of damage:
  - before handling the assembly, discharge your body by touching a grounded, metal object
  - handle all cards by their edges unless otherwise required
  - when possible, use grounded electrostatic discharge wrist straps when handling sensitive components

**Receipt of System Components**

When receiving a Sierra mass flow meter, carefully check the outside packing carton for damage incurred in shipment. If the carton is damaged, notify the local carrier and submit a report to the factory or distributor. Remove the packing slip and check that all ordered components are present. Make sure any spare parts or accessories are not discarded with the packing material. Do not return any equipment to the factory without first contacting Sierra Customer Service.

**Technical Assistance**

If you encounter a problem with your flow meter, review the configuration information for each step of the installation, operation, and setup procedures. Verify that your settings and adjustments are consistent with factory recommendations. Installation and troubleshooting information can be found in the Chapter 2 (Installation) and Chapter 6 Maintenance sections of this manual.

If the problem persists after following the troubleshooting procedures outlined in Chapter 6 of this manual, contact Sierra Instruments by e-mail (see inside front cover). For urgent phone support you may call (831) 373-0200 between 8:00 a.m. and 5:00 p.m. PST. In Europe, contact Sierra Instruments Europe at +31 72 5071400. In the Asia-Pacific region, contact Sierra Instruments Asia at +8621 5879 8521. When contacting Technical Support, make sure to include this information:

- The serial number (marked on the meters label)
- The firmware version (visible on the display at startup)
- The problem you are encountering and any corrective action taken
- Application information (flow range, gas, pressure, temperature and piping configuration)

**Using This Manual**

This manual provides information needed to install and operate the series TM100 Thermal Mass Flow Meter.

**Additional Resources**

Visit [Sierrainstruments.com](http://Sierrainstruments.com) for additional resources. Note: the most current versions of the TM100 documents can be found at <https://www.sierrainstruments.com/products/downloads.html>.

## Table of Contents

|  |                    |
|--|--------------------|
| <b>1. Introduction</b>                               | <b>Pages 9-21</b>  |
| a. Quick Start Guide .....                           | p. 9               |
| b. Menu Trees .....                                  | p. 11              |
| c. General .....                                     | p. 19              |
| <b>2. Installation (Mechanical)</b>                  | <b>Pages 21-34</b> |
| a. Lateral Placement .....                           | p. 23              |
| b. Welding Branch Outlet to Pipe (Insertion) .....   | p. 25              |
| c. Installation Depth .....                          | p. 26              |
| d. Orientation .....                                 | p. 28              |
| e. Mounting Instructions .....                       | p. 27              |
| f. Retractor Installation .....                      | p. 31              |
| <b>3. Wiring (Electrical)</b>                        | <b>Pages 35-45</b> |
| a. Wiring Access .....                               | p. 35              |
| b. Input Power .....                                 | p. 36              |
| c. Signal Wiring and HART Communication Option ..... | p. 37              |
| d. Pulse/Alarm Wiring (optional feature) .....       | p. 40              |
| e. RS485 Wiring: Modbus RTU .....                    | p. 42              |
| f. HART Handheld Wiring .....                        | p. 44              |
| <b>4. Operation (Standard Operation)</b>             | <b>Pages 46-68</b> |
| a. Start Up .....                                    | p. 45              |
| b. Programming .....                                 | p. 48              |
| c. TM-Cal™ .....                                     | p. 63              |
| d. Gas-Mix™ .....                                    | p. 65              |
| <b>5. Communication Protocols</b>                    | <b>Pages 70-83</b> |
| a. Modbus RTU (RS485) .....                          | p. 69              |
| b. BACnet .....                                      | p. 81              |
| c. HART .....  | p. 83              |



|  |              |
|--|--------------|
| 6. Maintenance                                 | Pages 85-93  |
| a. Safe Meter Removal from Retractor . . . . . | p. 85        |
| b. Troubleshooting . . . . .                   | p. 94        |
| 7. Appendices                                  | Pages 96-107 |
| a. Specifications . . . . .                    | p. 99        |
| b. Agency Approvals . . . . .                  | p. 102       |
| c. Dimensions . . . . .                        | p. 103       |
| d. Warranty . . . . .                          | p. 104       |
| e. Returning your meter . . . . .              | p. 104       |
| 8. Definitions                                 | Page 110     |
| 9. Index                                       | Page 113     |



# Quick Start Guide

Use the table below as a guide while using the worksheet on the next page to record your notes.

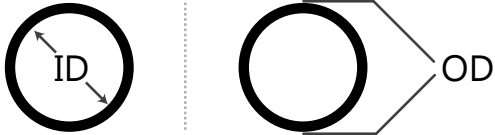
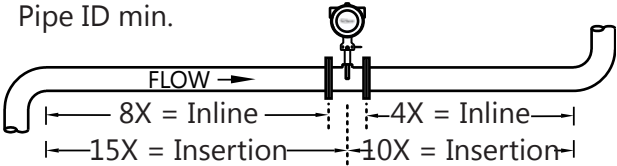
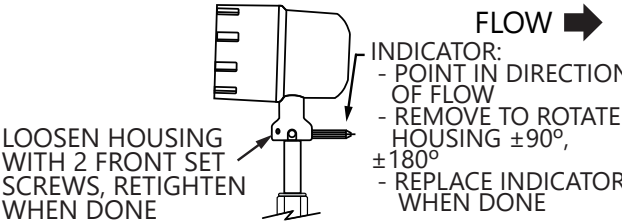
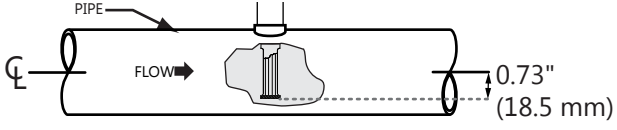
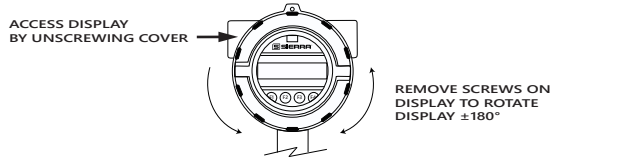
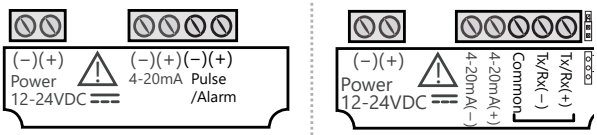
**NOTE!** Please read the entire quick-start procedure before beginning installation.

|           |   |  |
|-----------|---|--|
| <p>1.</p> | <p>Record inside diameter (ID). Ensure the actual pipe ID matches the pipe ID shown on the factory calibration certificate. If IDs do not match, refer to p. 59.</p>  |  <p>The diagram shows two circular cross-sections of a pipe. The left one is a simple circle with a double-headed arrow across its diameter labeled 'ID'. The right one is a circle with a pointed outer edge, also with a double-headed arrow across its diameter labeled 'OD'.</p>   |
| <p>2.</p> | <p>Record up/downstream straight-pipe requirements based on Pipe ID and meter style (insertion or inline). [refer to p. 23]</p>   | <p>Pipe ID min.</p>  <p>The diagram shows a horizontal pipe with a flow arrow pointing right. A meter is mounted on the pipe. For an inline meter, the distance from the meter to the pipe end is 8X. For an insertion meter, the distance is 10X. The diagram also shows a 15X requirement for an inline meter and a 4X requirement for an insertion meter.</p> |
| <p>3.</p> | <p>The Flow Direction Indicator must point in the direction of flow.<br/>The housing can be rotated for a better view of the meter's display. Note that the 2 set screws must be loosened before the housing will turn. [refer to p. 29]</p>  |  <p>The diagram shows the meter housing with a flow arrow pointing right. Text indicates: 'INDICATOR: - POINT IN DIRECTION OF FLOW - REMOVE TO ROTATE HOUSING ±90°, ±180° - REPLACE INDICATOR WHEN DONE'. Below this, it says 'LOOSEN HOUSING WITH 2 FRONT SET SCREWS, RETIGHTEN WHEN DONE'.</p>   |
| <p>4.</p> | <p>Ensure correct probe depth setting. If using 1 1/2" size pipe, please see note on p. 26.</p>   |  <p>The diagram shows a cross-section of a pipe with a probe inserted. The probe depth is indicated as 0.73" (18.5 mm).</p>   |
| <p>5.</p> | <p>Open the housing. If needed, the orientation of display can be rotated in 90° increments for a better view. [refer to p. 28 for more information]</p>  |  <p>The diagram shows the meter housing with arrows indicating rotation. Text says: 'ACCESS DISPLAY BY UNSCREWING COVER' and 'REMOVE SCREWS ON DISPLAY TO ROTATE DISPLAY ±180°'.</p>   |
| <p>6.</p> | <p>Ensure power wiring [p. 37] and 4-20mA wiring [p. 38 - p. 39] are properly connected. [refer to Wiring section p. 35 for more information]<br/>Verify the output signal wiring based on model type (Pulse/ Alarm or communication protocol) [refer to Wiring section p. 38 for more information]</p> |  <p>The diagram shows two terminal blocks. The left one has terminals for Power (12-24VDC), 4-20mA, and Pulse/Alarm. The right one has terminals for Power (12-24VDC), 4-20mA, Common, Tx/Rx (+), and Tx/Rx (-).</p>   |
| <p>7.</p> | <p>Apply power to the flow meter.</p>   |  <p>The diagram shows a power button icon on the left and a meter display on the right showing 'Initializing...'.</p>  |
| <p>8.</p> | <p>Check the remaining flow meter settings by accessing the meter settings either through the front panel of the display or by using the TM100-View™ Software. Record the settings in the spaces given for items A - F on the following page.</p>   |  |

Before applying power to your meter, use this worksheet to record your notes.

|    | Item to verify   | Serial Number: | Serial Number: | Serial Number: | Serial Number: |
|----|--|----------------|----------------|----------------|----------------|
| 1. | What is the Pipe ID?   | ID =           | ID =           | ID =           | ID =           |
| 2. | Calculate the Upstream/Downstream straight-pipe requirements | UP =<br>DN =   | UP =<br>DN =   | UP =<br>DN =   | UP =<br>DN =   |
| 3. | Is the flow indicator pointed in direction of flow?          | Y / N          | Y / N          | Y / N          | Y / N          |
|    | Must the housing be rotated for easy viewing?                | Y / N          | Y / N          | Y / N          | Y / N          |
| 4. | Is the probe depth setting correct?                          | Y / N          | Y / N          | Y / N          | Y / N          |
| 5. | Have you rotated the display for easier viewing?             | Y / N          | Y / N          | Y / N          | Y / N          |
| 6. | Verify proper power wiring                                   |                |                |                |                |
| 7. | Verify proper input/output wiring                            |                |                |                |                |

After applying power to your meter, check items A - E below by accessing the meter settings either through the front panel of the meter's display or by using the TM100-View™ software tool.

|    |  |                 |                 |                 |                 |
|----|--|-----------------|-----------------|-----------------|-----------------|
| A. | Which flow units have been set in meter? (SCFM, KG/H, etc..)                 |                 |                 |                 |                 |
| B. | Correct values for reference temperature and pressure?                       | Y / N           | Y / N           | Y / N           | Y / N           |
| C. | Confirm the pipe ID listed above same as "Pipe_id="                          |                 |                 |                 |                 |
| D. | Verify 4mA and 20mA meter settings   | 4mA =<br>20mA = | 4mA =<br>20mA = | 4mA =<br>20mA = | 4mA =<br>20mA = |
| E. | Confirm the correct gas is selected for your application in the Gas-Mix menu |                 |                 |                 |                 |

Your Notes:

If you are experiencing any problems after completing this procedure, please call the Sierra Instruments Tech Department at 831-373-0200 to review this information.

# Menu Trees

Fig. 1.1: TM100 Menu Tree - Main Menu

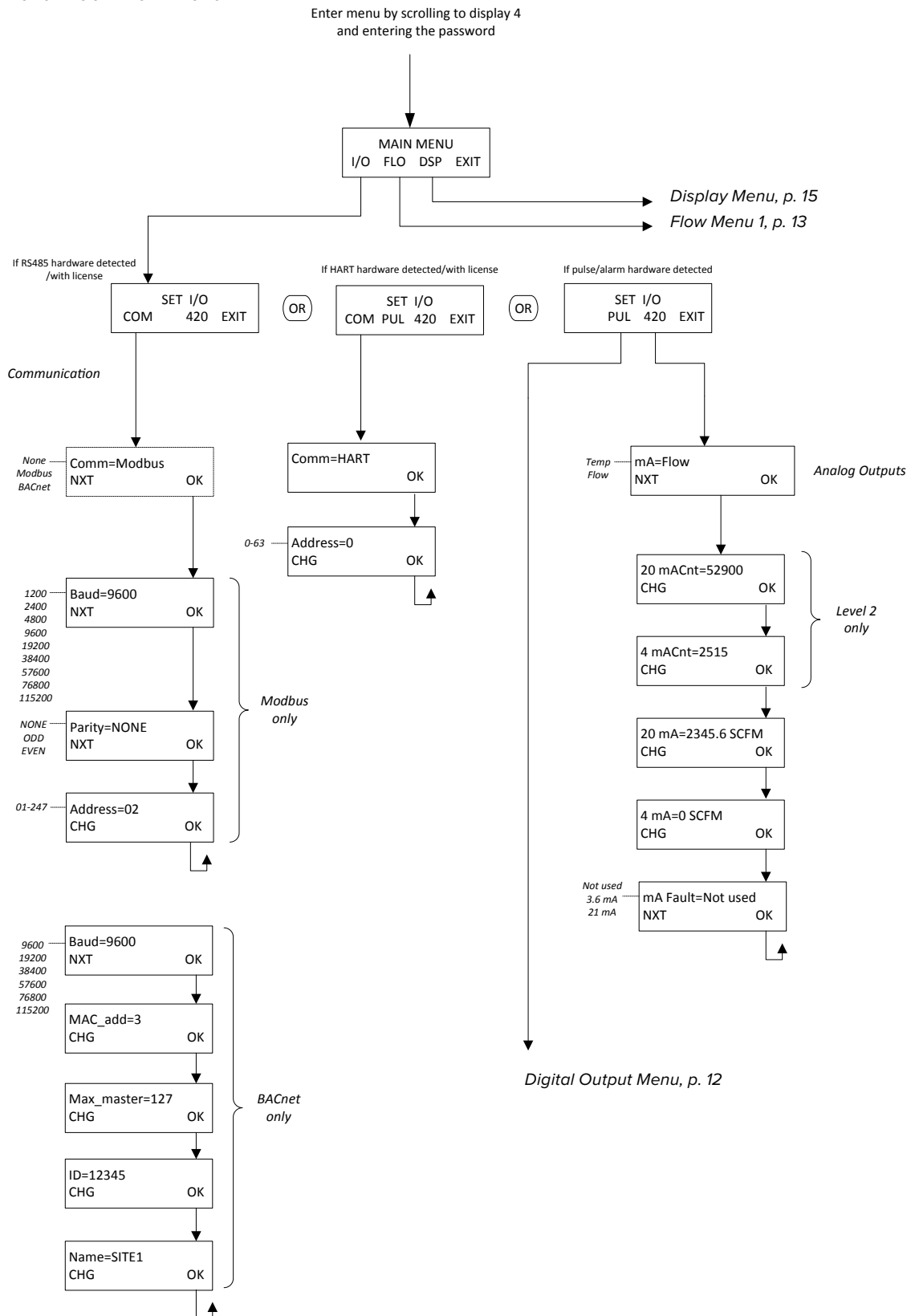
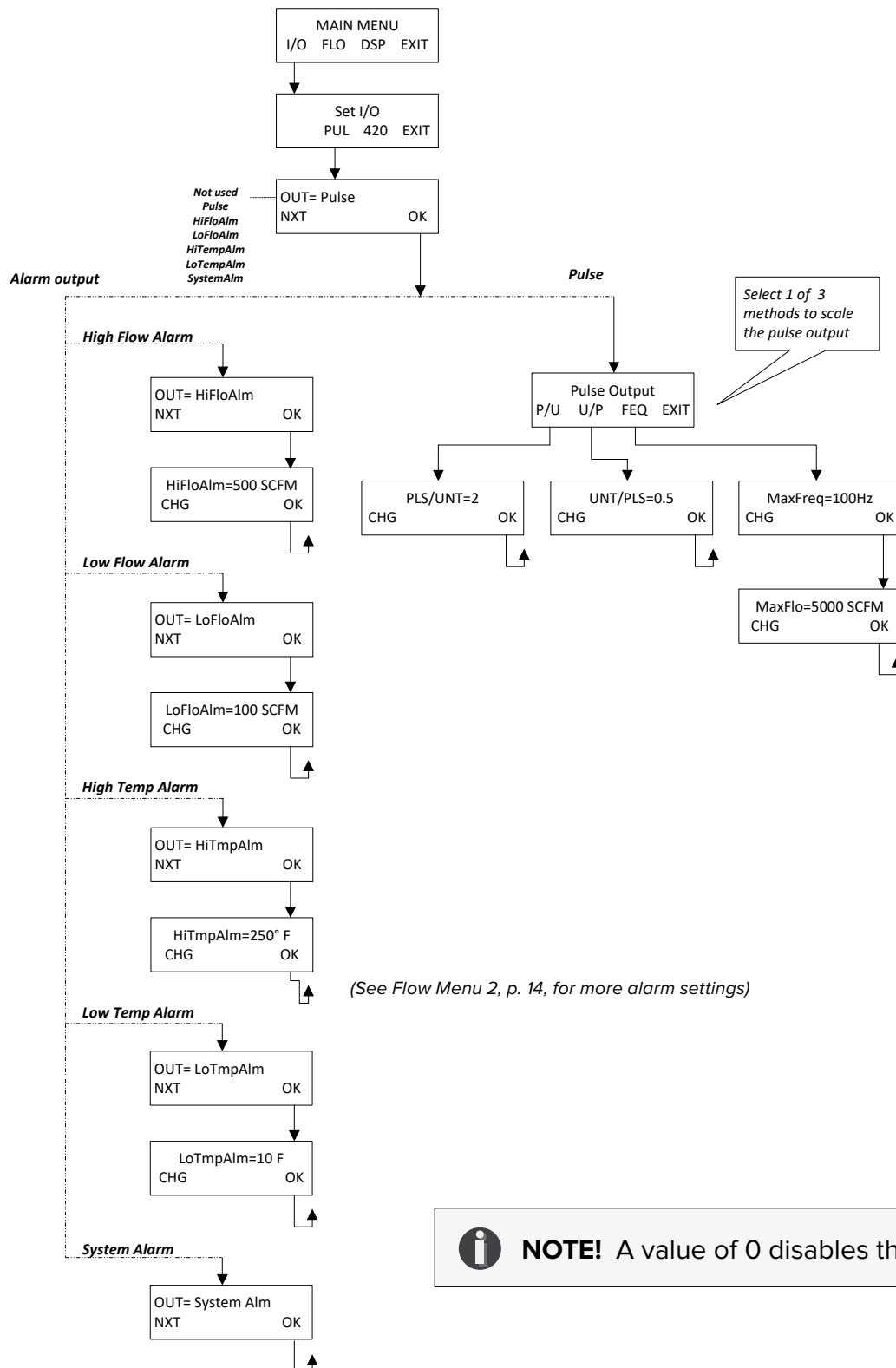

Fig. 1.2: TM100 Menu Tree - Digital Outputs



**NOTE!** A value of 0 disables the alarms

Fig. 1.3: TM100 Menu Tree - Flow Menu 1

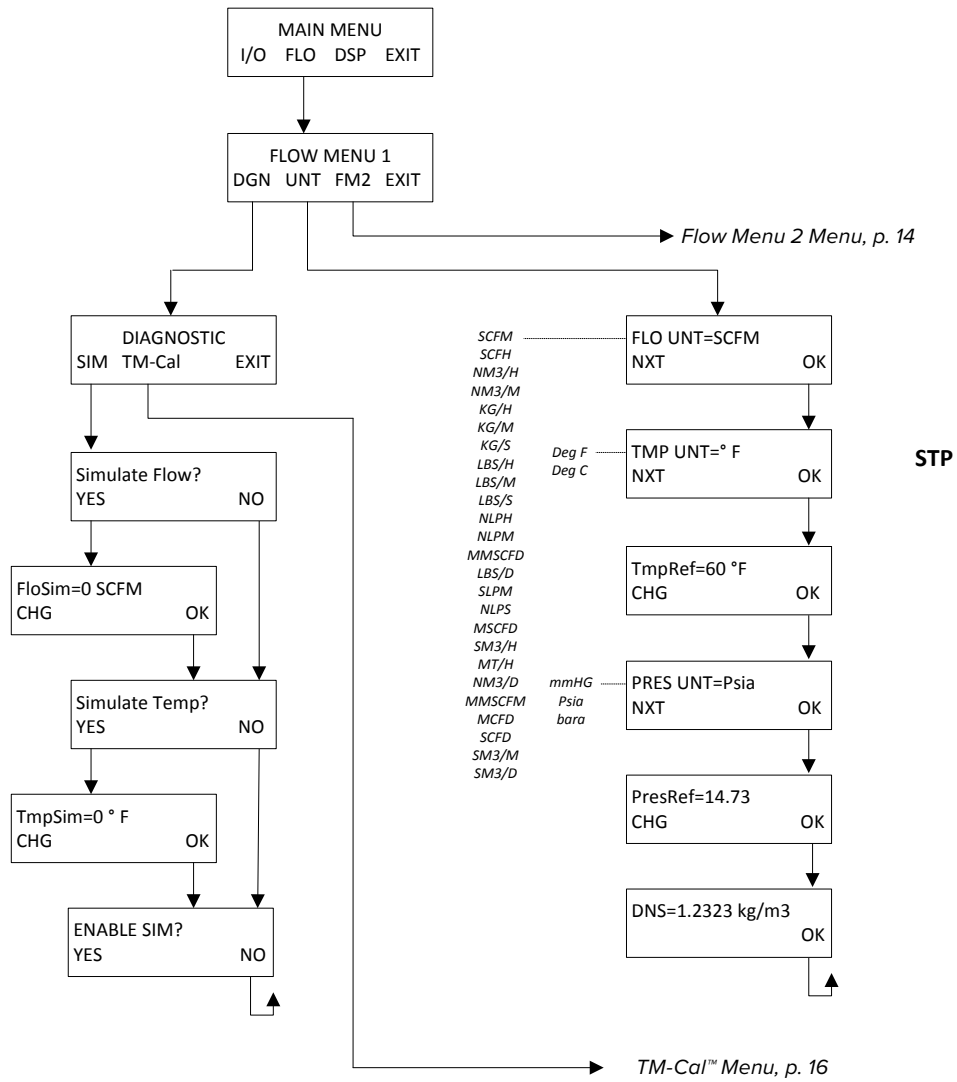
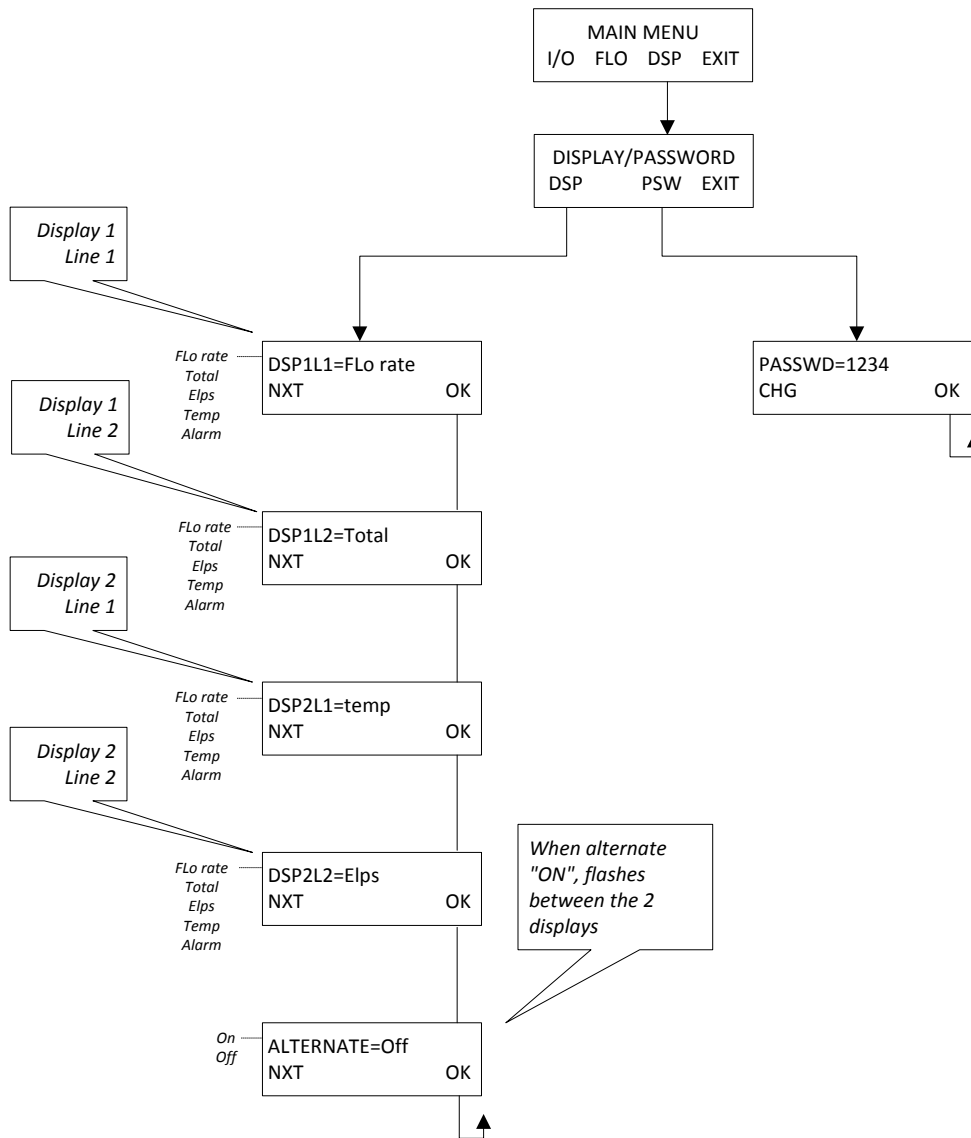



Fig. 1.5: TM100 Menu Tree - Display Menu



**NOTE!** All readings updated every second

- Flo Rate = Flow rate of process gas
- Total = Total flow of process gas
- Elps = Elapsed time since reset of flow total
- Temp = Temperature of process gas
- Alarm = Notification of errors; diagnostic errors

Fig. 1.6: TM100 Menu Tree - TM-Cal™ Menu

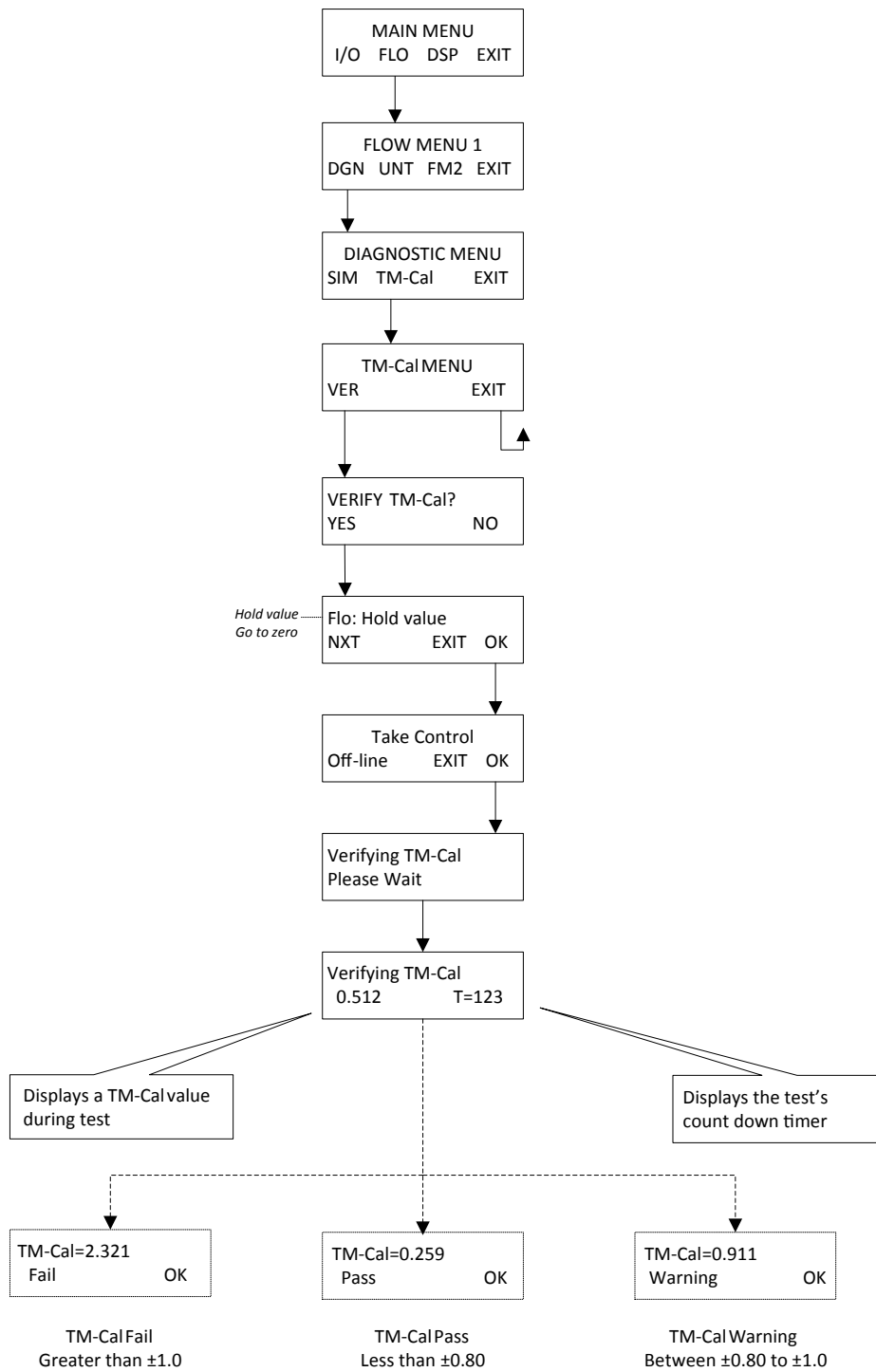



Fig. 1.7: TM100 Menu Tree - Gas-Mix™ Menu

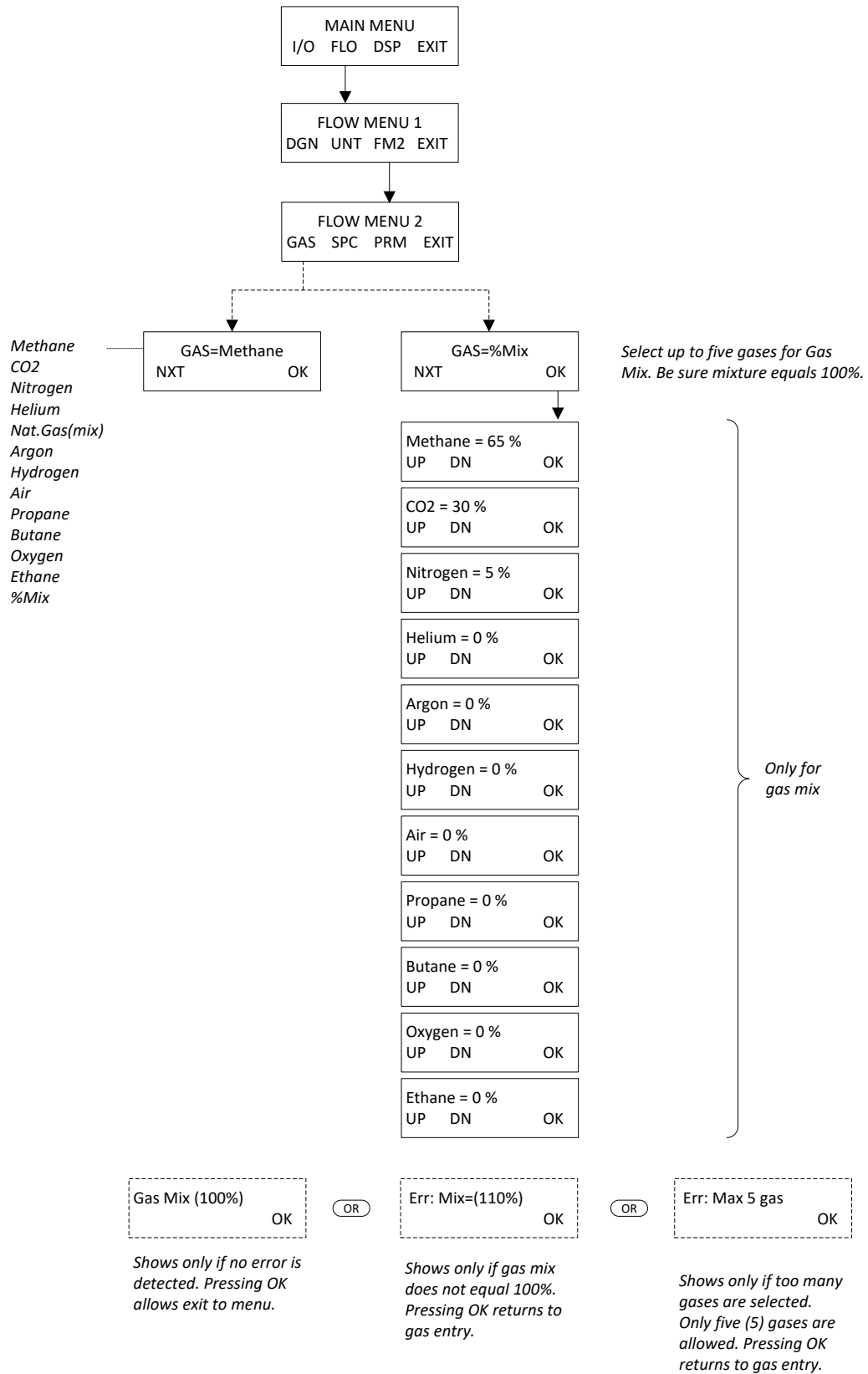

Fig. 1.8: TM100 Menu Tree - Engineering Screens

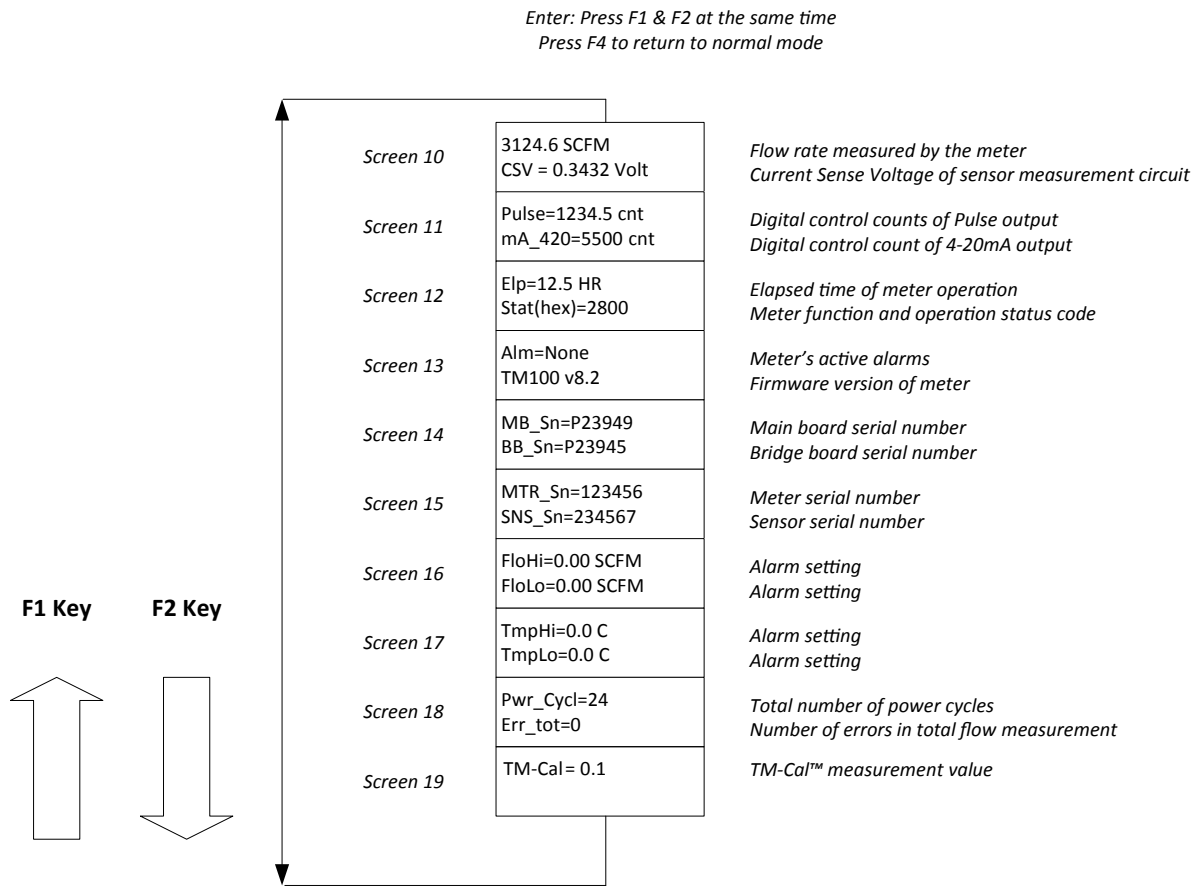
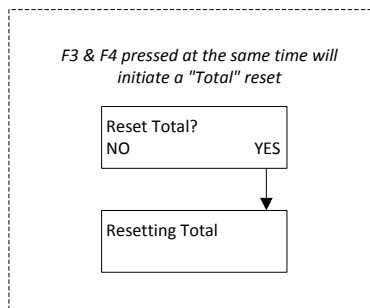

Fig. 1.9: TM100 Menu Tree - Reset Flow Total



**Welcome**

Thank you for purchasing the TM100 Thermal Gas Mass Flow Meter from Sierra Instruments. The TM100 is one of the most technically advanced flow meters in the world. Extensive engineering effort has been invested to deliver advanced features, accurate measurement performance, and outstanding reliability.

This instruction manual contains the electrical and mechanical installation instructions as well as details for programming, maintaining and troubleshooting the meter. This manual is divided into the following sections: Introduction, Installation, Wiring, Operation, Communications, Maintenance, Appendices, Definitions, and Index.

**Theory of Operation**

The TM100 is an innovative thermal mass gas flow meter and temperature transmitter. It is microprocessor-based and field programmable. The TM100 thermal sensor operates on the law that gases absorb heat. A heated sensor placed in an air or gas stream transfers heat in proportion to the stream's mass velocity. There are two sensor elements. One sensor element detects the gas temperature and a second element is maintained at a constant temperature above the gas temperature. The energy transferred from the heated element is proportional to the mass flow velocity. The TM100 flow meter maintains accurate flow measurement over a large temperature and pressure range.

**Mass Flow**

The TM100 measures mass flow; an advantage over other flow meters which measure volumetric flow rate. Volumetric flow is incomplete because temperature and pressure are unknown and must be measured separately. For example, the mass flow of a gas depends on its temperature and pressure. As temperature and pressure changes, the gas volume changes but not its mass. Therefore a device measuring mass flow is independent of temperature and pressure changes. The TM100 provides a direct measurement of gas flow in mass units (kg/hr, lb/hr), standard units (SCFM, SLPM) or normal units (NM<sup>3</sup>/hr, NLPM) with no additional temperature or pressure measurements required.

**Calibration Validation**

Validate the calibration of the TM100 in the field using the TM-Cal™ test. The goal of Calibration Validation is to provide operators with the ability to verify that the meter is capturing accurate data at scheduled recalibration times - or at any time - instead of sending the meter back to the factory for recalibration. By performing TM-Cal™ in the field, operators can verify that the meter is running accurately by testing the functionality of the sensor and its associated signal processing circuitry. This test can be done in the pipe under normal process conditions.

**Flow Calibration**

Every TM100 flow meter is set to the customer's configuration at the factory using an App ID which is generated by the on-line configurator. The App ID specifies the gas type, flow range, serial communication and other settings in the meter. If these settings match the final customer application, the meter is ready to use. Sierra Instruments maintains instrument calibration data on every flow meter. Calibration files include details on process conditions, customer gas, line size and other information. All NIST-traceable equipment utilized for the calibration procedure is identified on the Calibration Certificate, which is sent with every flow meter.

**I/O Description**

Sierra's TM100 features a galvanically isolated 4-20mA analog output with HART communication option on the first channel. The second channel can be a pulse/alarm output, or a serial communication option for MODBUS RTC (RS-485) or BACnet MS/TP (RS-485). There is also a USB port for interfacing a laptop or computer.

Sierra's TM100-View is a free PC-based software program that interfaces to the TM100 through the USB port. TM100-View can be used to display flow meter readings and change the configuration. The software is available for download on Sierra Instrument website. .

## Installation (Mechanical)

### TM100 Functional Diagram

An optional on-board 2 line x 16 character backlit LCD display shows flow rate, total flow, elapsed time, process gas temperature, and alarms. The display is also used in conjunction with the Configuration Panel for field configuration of flow meter settings such as gas selection, 4-20mA scaling, pulse output scaling, pipe area, flow cutoff, flow filtering, display configurations, diagnostics, communication parameters, and alarm limits.

Fig. 1.10: TM100 Function Diagram

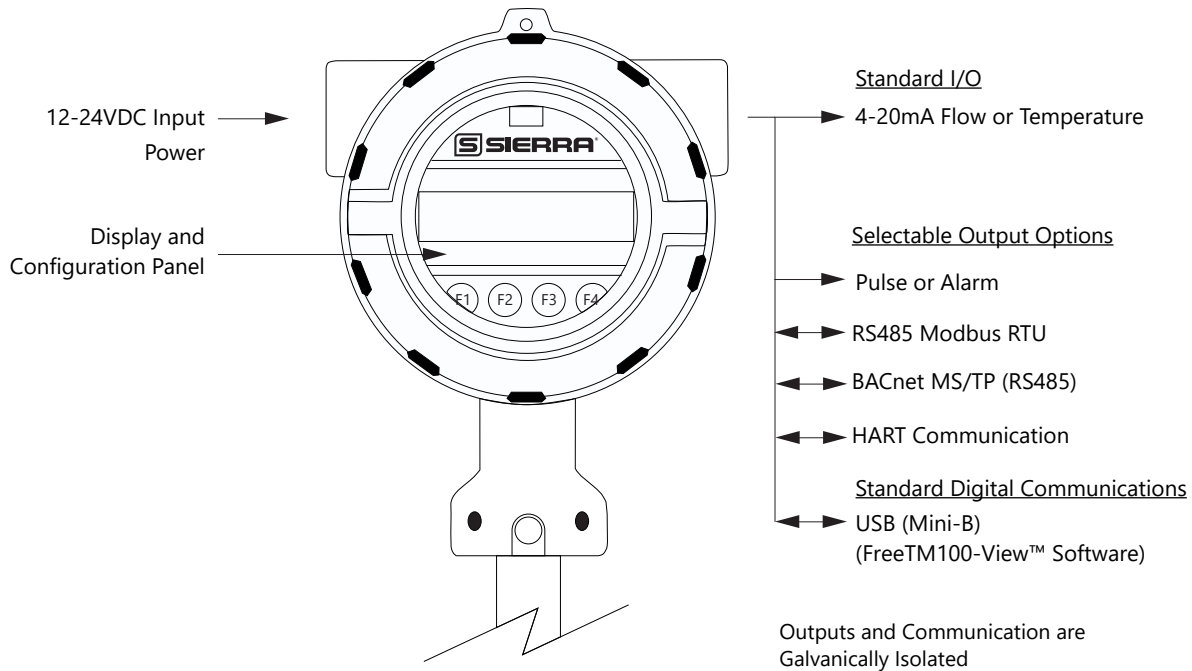

## Installation Scope

This section describes how to install the Sierra Instruments TM100 Flow Meter and how to get started. Installation methods will vary according to the flow meter type (insertion or inline).

For TM100 Insertion Types:

1. Determine lateral position on the pipe.
2. Determine radial position of probe, if moisture or condensation is present in the gas.
3. Verify sensor installation depth.
4. Determine sensor orientation in relation to sensor length and direction of flow.
5. Determine if the display orientation must be changed.
6. Ensure proper tightening of compression fitting for mounting meter.

For TM100 Inline Types:

1. Determine lateral position on the pipe.
2. Ensure the correct flow body orientation in relation to direction of flow in pipe.
3. Determine if the display orientation must be changed.
4. Ensure proper tightening of compression fitting for mounting meter.

Installation procedures must be performed using a combination of the end user's best engineering practices, in compliance with local codes, and with manufacturer's recommendations.



## General Precautions

The following general precautions should be observed:

1. Exercise care when handling the flow meter to avoid damaging the probe, sensor or enclosure
2. Close any unused conduit openings in the enclosure with plugs certified for your application.
3. The enclosure cover must be closed except during configuration or at times during installation.
4. Mounting TM100 in direct sunlight can cause the temperature inside the enclosure to increase beyond design limits, resulting in failure of LCD display and reduced component life. It is recommended that a sunshade be installed to avoid direct sunlight (see maximum enclosure operating temperature specification).
5. Ensure the flow direction indicator/pointer for the meter is in line with the direction of flow in the pipe.
6. Do not install the TM100 enclosure near an igniter, igniter-controller or switching equipment.
7. Do not install an external power supply in a cabinet containing an igniter controller or switching equipment.
8. For accurate flow measurement, review flow meter placement instructions before installation to ensure a proper flow profile in the pipe.
9. For safety reasons, Teflon ferrules are only appropriate for applications with pressures of 60 psig or less. At higher pressures, use of a Teflon ferrule risks unwanted probe movement or ejection of the probe from the pipe. For all applications above 60 psig, the standard stainless steel ferrule is required.

### Instructions for Flow Meter Lateral Placement

Install the TM100 flow meter so that it is far enough away from bends in the pipe, obstructions, or changes in line sizes to ensure a consistent flow profile. See Fig. 2.1 below for your meter type.

Fig. 2.1: Upstream and Downstream Pipe IDs for TM100 Insertion and TM100 Inline Flow Meters

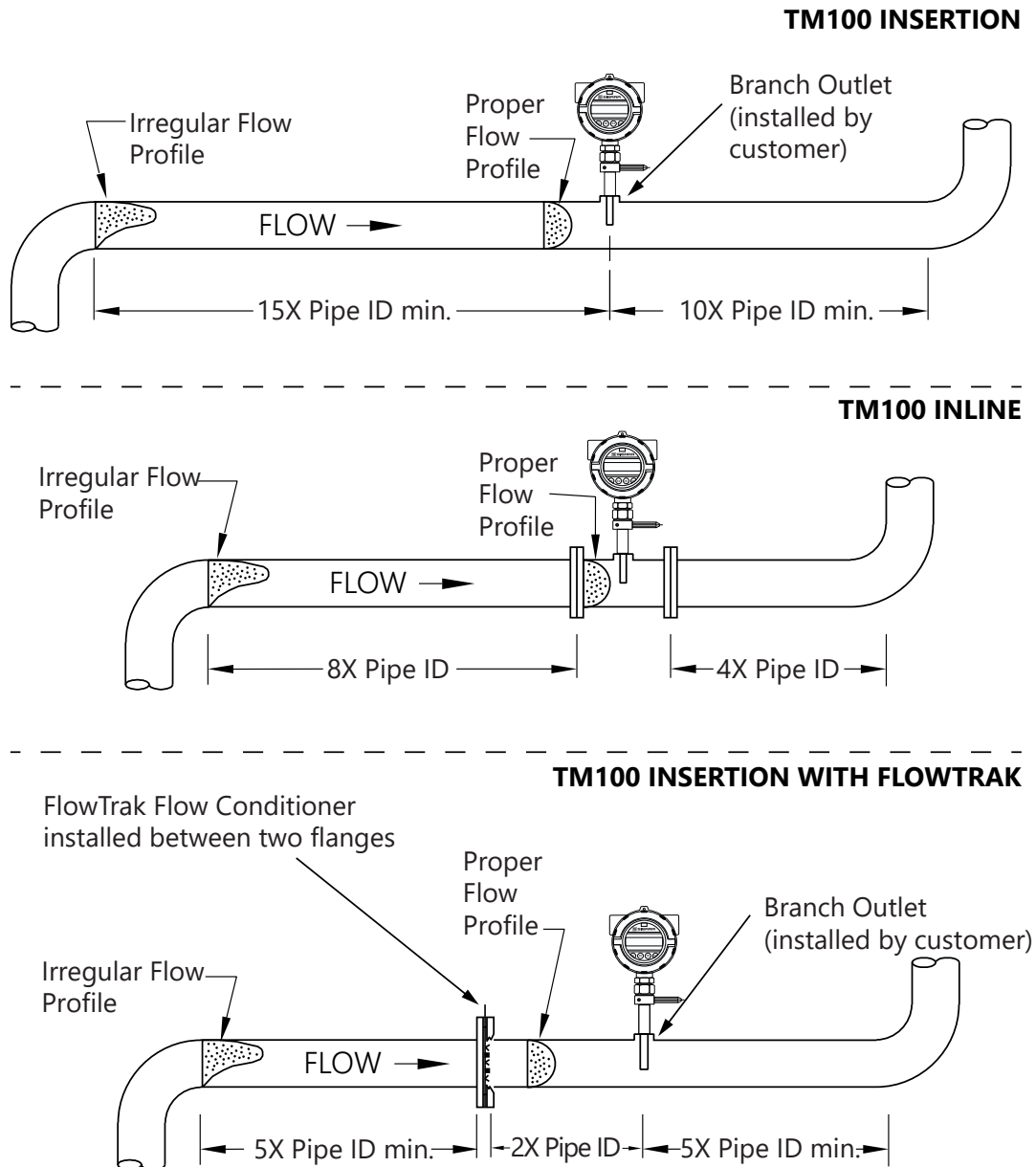

#### **i** NOTE!

- Pipe ID = Inside Diameter
- The probe diameter is  $\frac{3}{4}$ "
- An irregular flow profile will affect sensor accuracy
- See FlowTrak installation instructions for more information

**Radial Probe Position - Moisture in the Gas or Condensation**

The radial position of the meter may help prevent moisture and condensation from forming on the sensor and disrupting accurate flow measurement. Sierra Instruments recommends that our flow meters be used in dry gas conditions for highest accuracy whenever possible. Contact Sierra for further recommendations.

*Fig. 2.2: Installation at 180°*

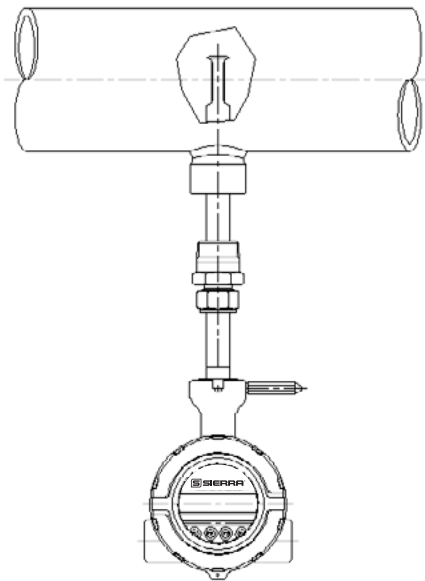
**Alternate Installations - Vertical Pipes or Restricted Installation Spaces**

When restricted physical installation space exists, the TM100 can also be installed at other angles. Please note that the display and the enclosure orientation can be rotated in 90° increments.

*Fig. 2.3: Alternate Installation at 90° (CCW)*

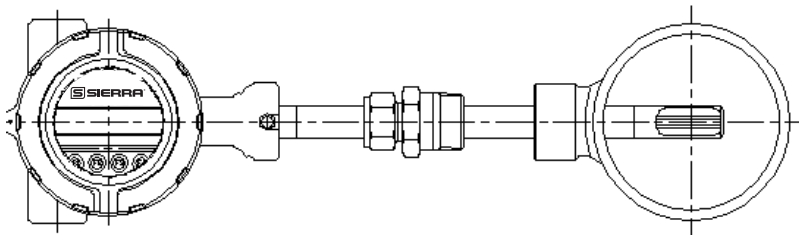



### Welding Branch Fitting to Pipe (TM100 Only)

The probe of the TM100 must be installed perpendicular in the pipe to measure flow accurately. Use the following steps to ensure that the branch fitting is correctly welded to the pipe.

Directions:

1. Drill a 0.781" (25/32") hole through the wall of the pipe (1 wall only).
2. Assemble the compression fitting and branch fitting hand tight onto the probe of the TM100.
3. Insert the probe into the hole in the pipe and use the TM100 probe and compression fitting to align the branch fitting with the hole and the probe perpendicular to the pipe.
4. Tack-weld the branch fitting carefully onto the pipe.
  - Before welding the fitting completely, verify the probe is aligned to the center of the pipe and the hole is centered in the branch fitting (see Figure 2.4).
5. To verify that the correct hole position has been achieved, carefully slide the 0.75" sensor in and out of the branch fitting and 0.781" hole.



**WARNING!** Do not force the 0.75" sensor through the 0.781" hole. Forcing it through the 0.781" hole can damage the probe.

6. Verify that the temporary weld of the branch fitting positions the probe window on the pipe's centerline.
  - Figure 2.4 shows an incorrect welding of the branch fitting, causing the 0.75" sensor to be "off center".
7. Once the branch fitting is aligned properly, remove the 0.75" sensor from the branch fitting and finish welding. Then verify the probe is still aligned with the center of the pipe.
8. Set the depth of the flow meter (see "Fig. 2.5: Cross Section of Insertion Sensor Depth in Pipe" on page 26).
  - Do not tighten compression fitting until proper depth of flow meter is determined. See Fig. 2.5.

Fig. 2.4: Alignment of Branch Fitting

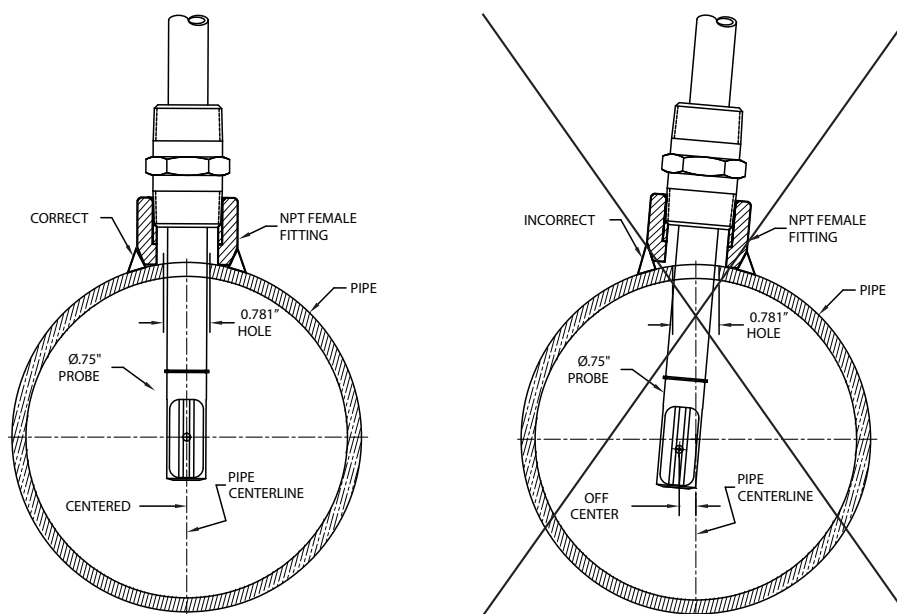

**Installation Depth**

The installation depth of the sensor in the pipe is dependent on the pipe size. To get the most accurate reading, proper placement of the sensor window within the pipe is necessary. As shown in Fig 2.5, the end of the sensor window should be 0.73" (18.5 mm) past the center line of the pipe. Review the dimensional drawing below with the following equation to calculate insertion depth:  $L + D/2 + .73" = \text{insertion depth}$ . Insertion depth is measured from the top of the compression fitting to the bottom end of the probe.



**CAUTION!** For a 1½" pipe, do not tighten compression fitting without 0.2" distance from wall or damage to probe will occur.

Fig. 2.5: Cross Section of Insertion Sensor Depth in Pipe

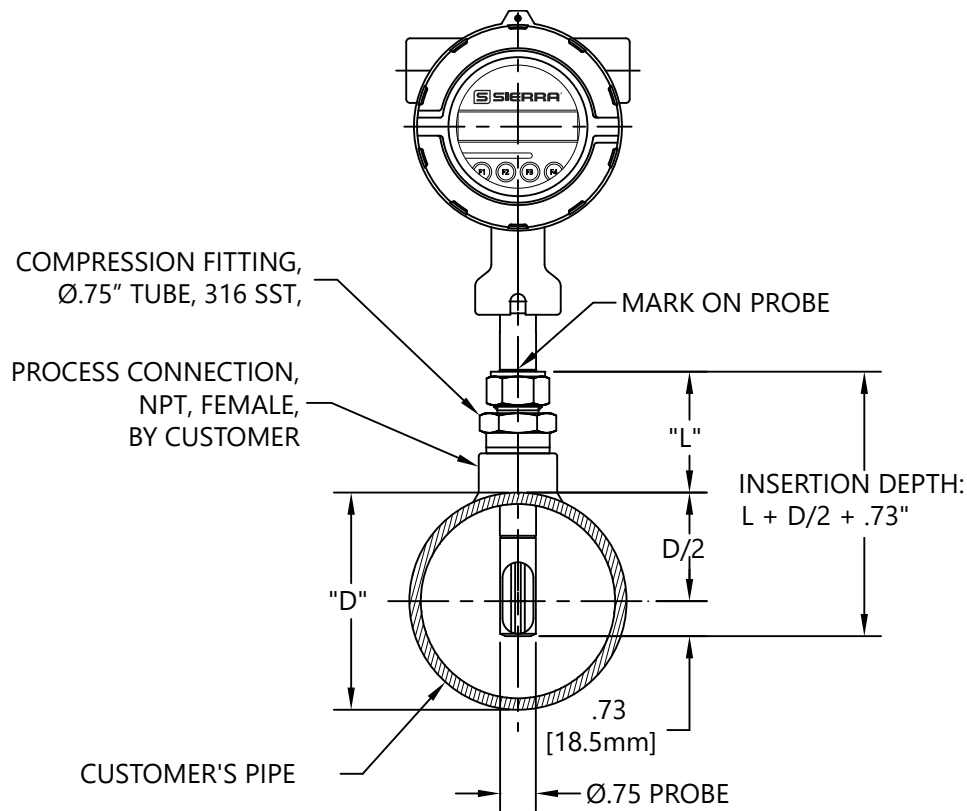

**Mounting Instructions - Compression Fittings (TM100 Only)**

The TM100 is mounted through a 0.781" hole and a female NPT branch outlet in the customer's pipe. Insertion style flow meters are not designed for use in pipes smaller than 1½".

- Install the compression fitting into the female NPT branch outlet.
- When installing in a 2" pipe or larger, install the end of the probe 0.73" (18.5 mm) past the center line of the pipe (refer to figure 2.5) .
- When installing into a 1½" pipe carefully install the probe into the pipe until it touches the opposite wall and pull back 0.2".
- Rotate the nut finger-tight.
- Further tighten the nut just enough until the tube will not turn by hand or move axially in the fitting.
- Mark the nut at the 6 o'clock position.
- While holding the fitting body steady, tighten the nut one and one-quarter (1 ¼) turns to the 9 o'clock position. See Figure 2.6.

Fig. 2.6: Proper Tightening of the Compression Fitting Nut

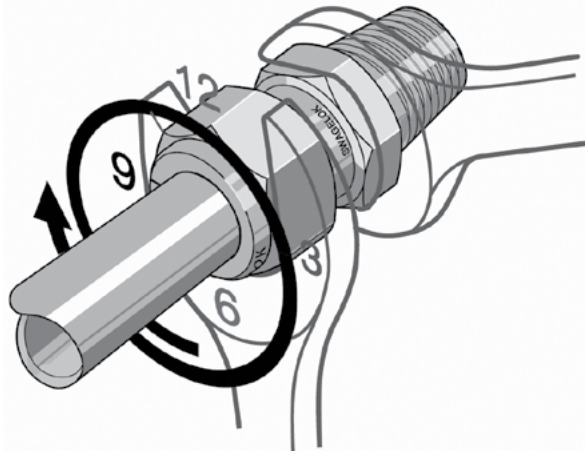

**NOTE!** Before removing a probe with compression fitting, mark the tube at the back of the nut, and mark a line along the nut and fitting body. Use these marks when reinstalling the probe. Reference the instructions on p.28.

**NOTE!** When installing a probe with compression fitting that has been tightened previously, use the instructions on p.28.

**CAUTION!** For a 1½" pipe, do not tighten compression fitting without 0.2" distance from wall or damage to probe will occur.

**CAUTION!** Once the stainless steel compression fitting ferrule is locked onto the probe, the probe can be removed or rotated, but the insertion depth is locked in place.

**CAUTION!** If the compression fitting is not properly tightened or the recommended pressure is exceeded, the fitting can slip on the probe and cause damage to the meter or bodily harm.

**Mounting Instructions - Compression Fittings (Inline and Insertion Meters Previously Installed)**

In cases where a compression fitting has already been swaged in an inline flow body or an insertion meter, use the following procedure.

- Carefully insert the probe with swaged ferrules into the fitting until the front ferrule seats against the fitting (see Figure 2.7).
- Verify that the probe is installed the correct depth in the pipe (refer to Figure 2.5 on p. 26).
- Rotate the nut with a wrench until the probe and nut are in their previously marked positions, or you feel a significant increase in resistance (see Figure 2.7).
- Tighten the nut slightly (approximately 1/8 turn).

*Fig. 2.7: Proper Re-Tightening of the Compression Fitting Nut*

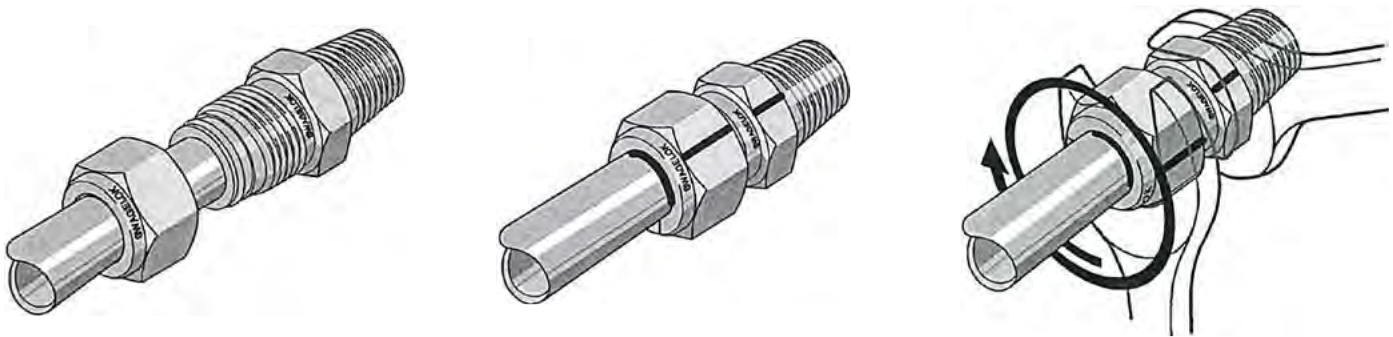

**CAUTION!** Do not use a gap inspection gauge with reassembled fittings.

### Rotating the Enclosure

The TM100 enclosure has been designed to allow the enclosure to rotate for optimal viewing of the display. To rotate the enclosure, first loosen the two set screws near the Flow Direction Indicator, then unscrew and remove the flow direction indicator. Rotate the enclosure into the desired position, reinstall the flow direction indicator, and tighten the set screws. Do not rotate the enclosure more than 360 degrees.

### Direction of Flow and Orientation of the Probe

Install the meter with the flow direction indicator pointing in the direction of flow and centered on the middle of the pipe. The rotational misalignment of the flow direction indicator must be less than 2 degrees.

Fig. 2.8: Orientation of Flow Meter

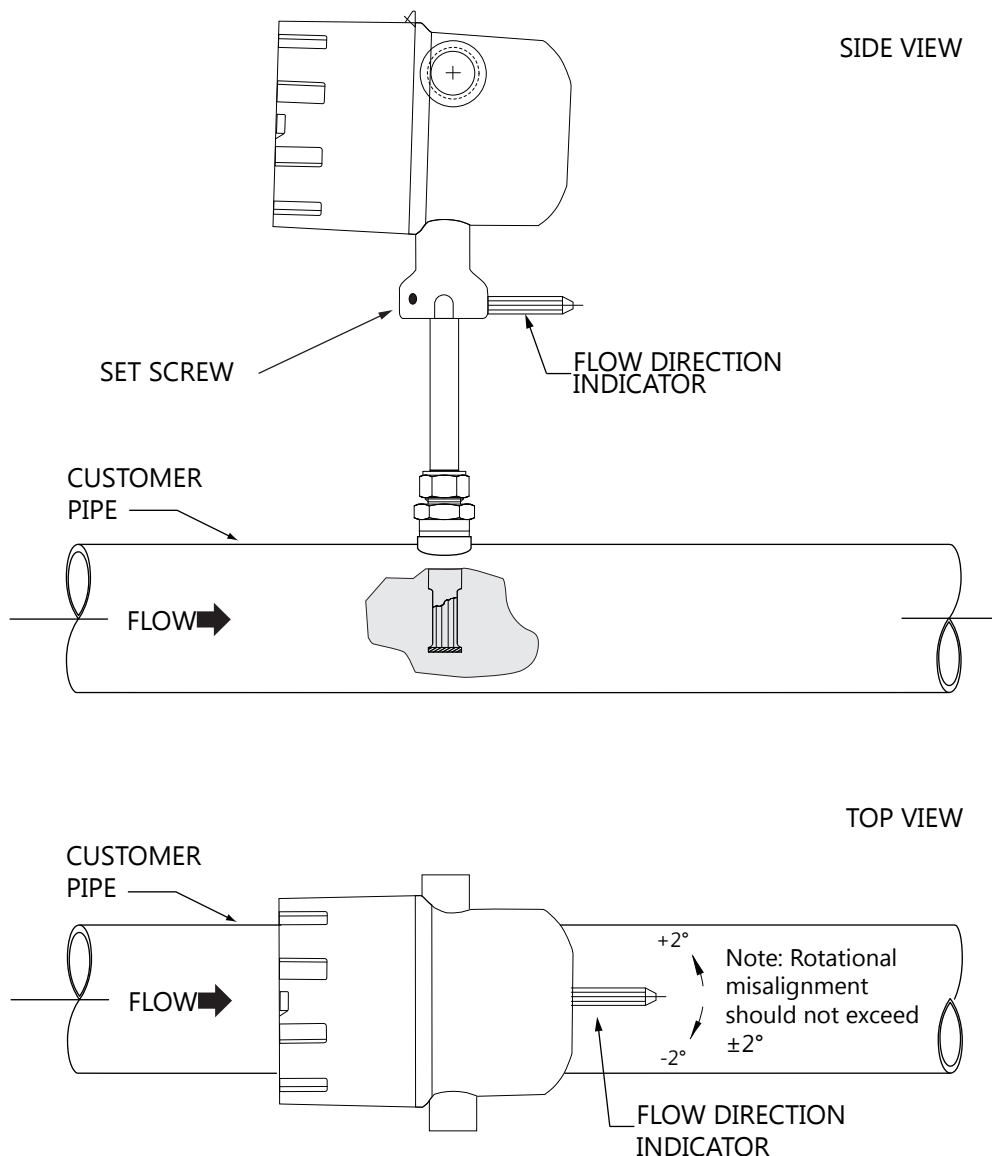

### Changing the Orientation of the TM100 Optional Display

The optional display can be rotated in 90° increments for optimum viewing of the screen. First, open the enclosure by unscrewing the enclosure cap and loosen the two captive screws to open the display assembly. Detach the display board from the metal shield by loosening the three screws on the back of the round shield. Rotate the display board to the desired orientation. Ensure that the display cable is routed flat and straight through the display hinge to prevent binding. Reattach the display board to the metal shield by tightening the three screws. Close the display assembly and secure it to the enclosure with the two captive screws. Finally, install the enclosure cover back on the front of the enclosure.

Fig. 2.9: Rotating the Display Orientation

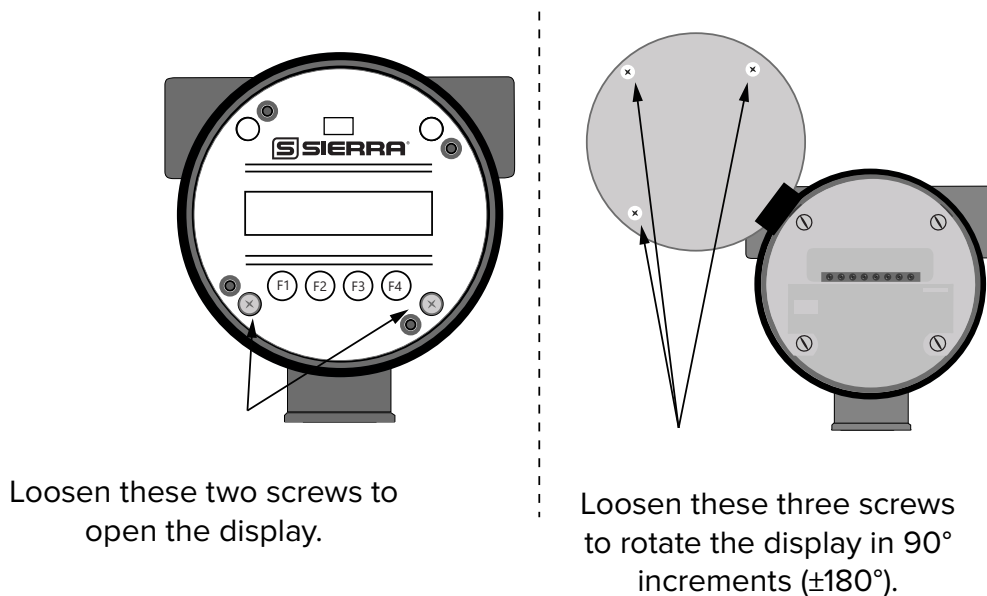

### Installation of a New Retractor Assembly

1. Remove collar clamp from probe using a 3/16" Hex Key.
2. Remove meter probe from retractor assembly and leave the ball valve open. Keep the collar spacer on the probe so it is not misplaced.
3. Install the valve assembly on the pipe, by tightening the Hex Nipple with a 1 3/8" wrench.

Fig. 2.10: Retractor Assembly With and Without Probe Installed

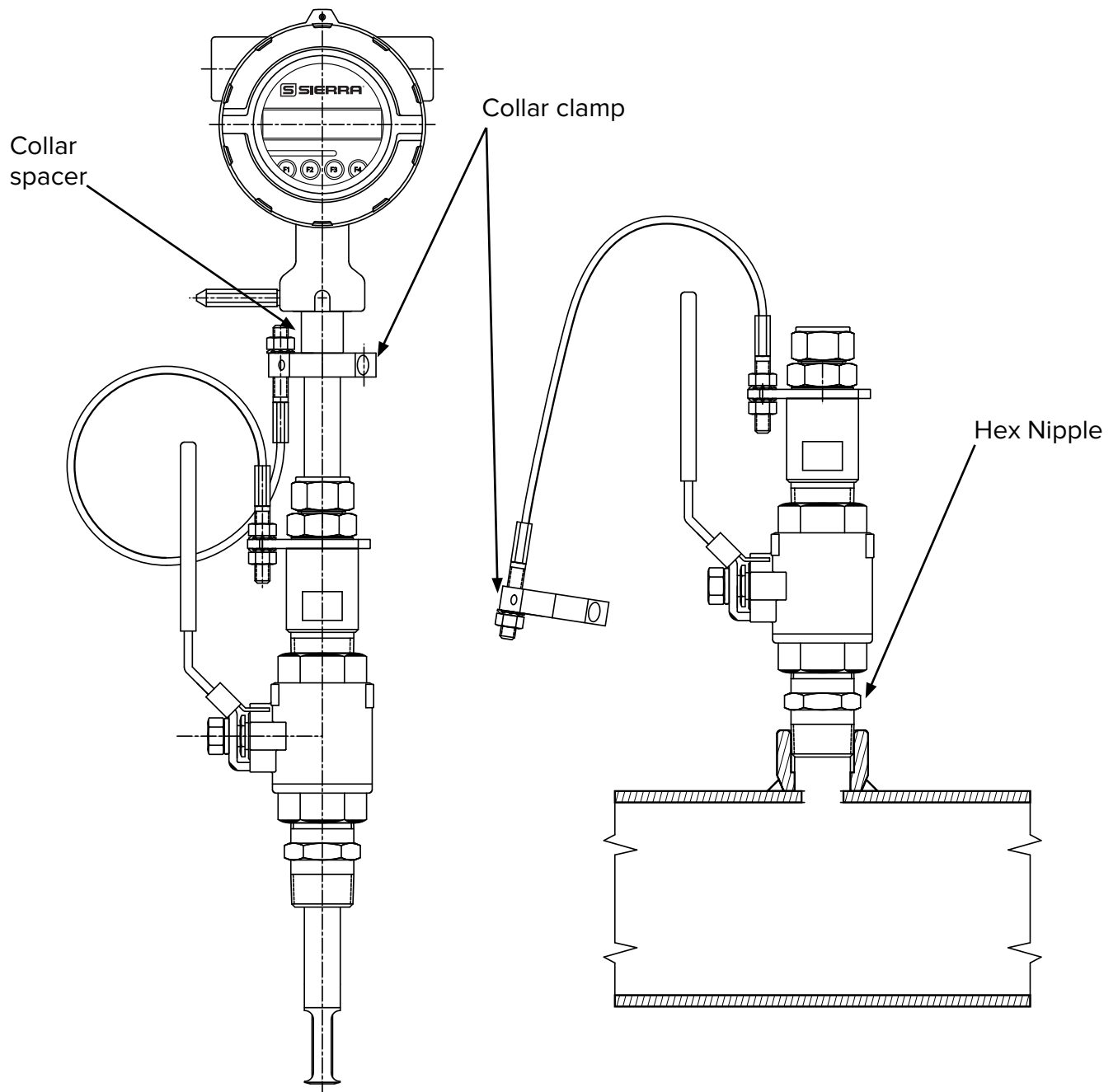

- Carefully slide the probe through the retractor assembly and through the hole to see if there is interference by touching the pipe wall with the end of the probe on the far side or until the probe cannot go deeper. Remove the probe. Remove the retractor and rework the hole, if required.

Fig. 2.11: Verify Probe Insertion

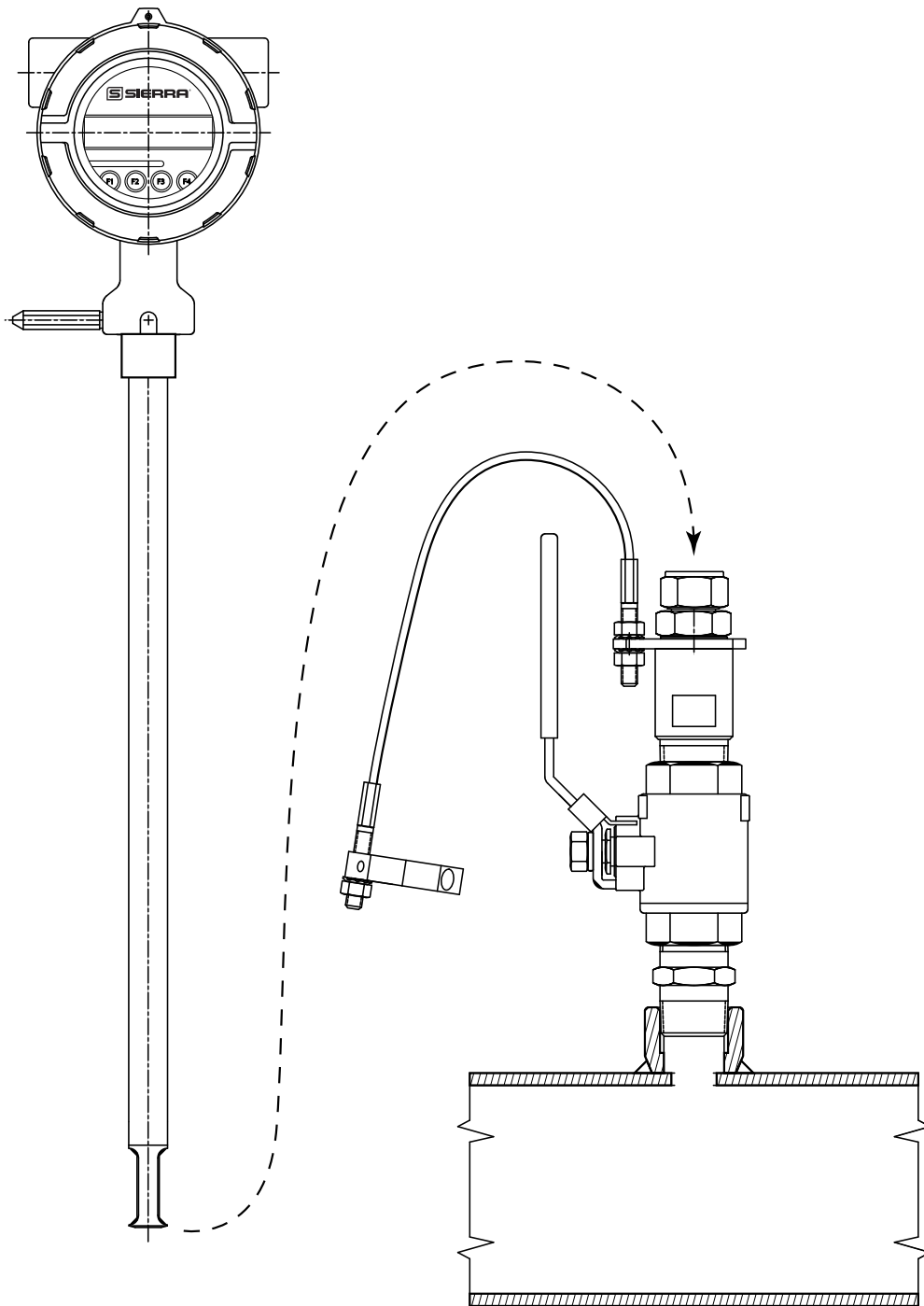



5. Using the equation  $(L + D/2 + 0.73)$  from Figure 2.12, calculate the insertion depth and mark on the probe while measuring from the end of the probe.
6. The Retractor Clearance table of Figure 2.21 lists the space required to remove the meter from the retractor. Use the model code of your meter to determine the dimension.

Fig. 2.12: Determining and Marking Insertion Depth

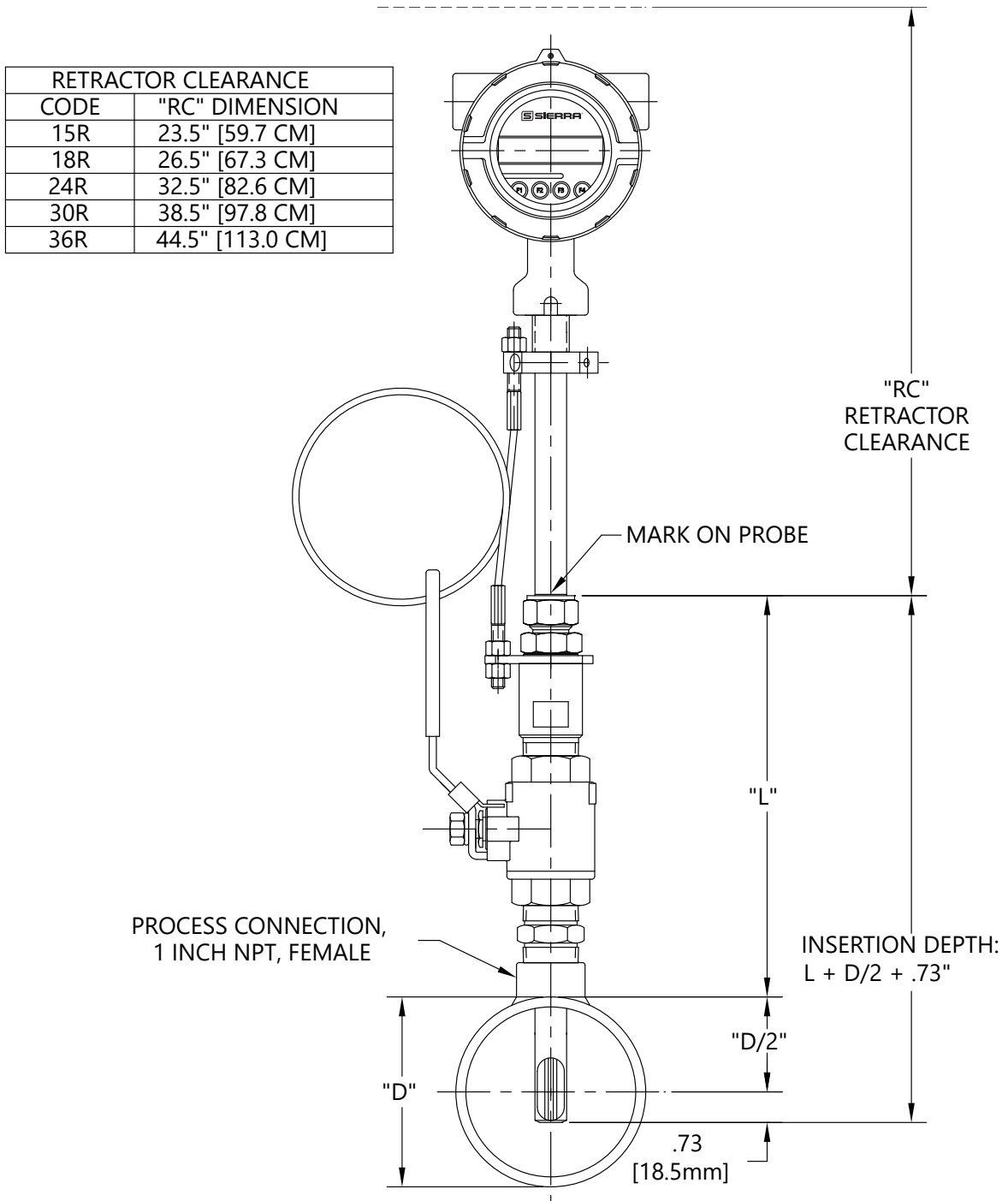

7. Insert probe back into the retractor to the depth mark and hand-tighten the compression fitting. Make sure collar spacer is in place on the probe.
8. Verify that flow direction indicator is in line with pipe and in the direction of flow.

Fig. 2.13: Installed Retractor

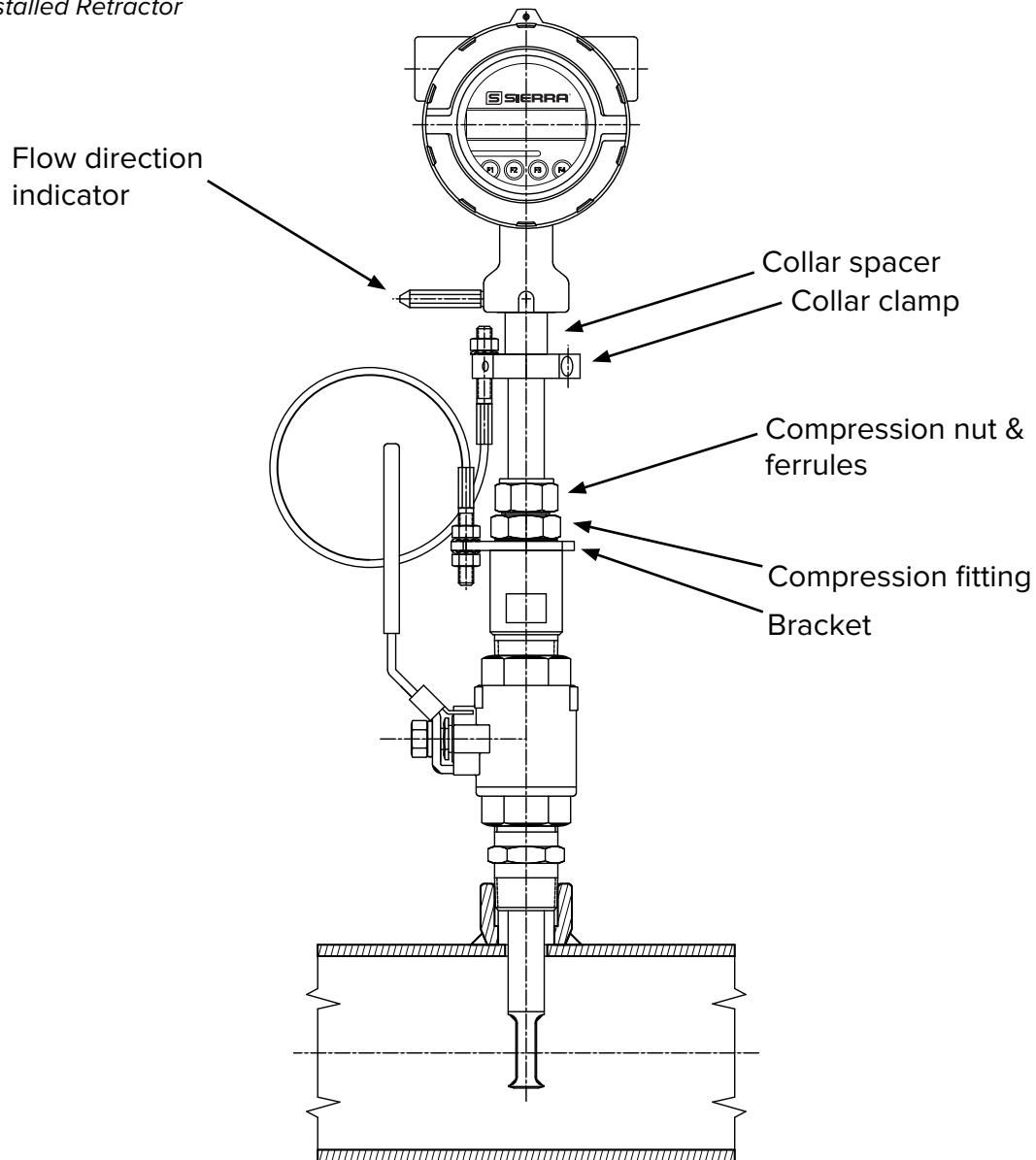

9. Fully tighten compression fitting (refer to the instructions on p. 27).
10. Install collar clamp back on probe just below the collar spacer. Install collar so that the cable mounting hole is in line with the mounting hole on the bracket.



**NOTE!** For instructions on how to properly remove and replace the meter from a retractor, please refer to "Instructions for Removing and Inserting the Meter from a Pressurized Pipe using the Retractor" on page 90.

## Wiring

### Wiring Instructions

To wire the TM100 connect the power and signal wires to the terminal blocks according to the label and instructions on the following pages.

Fig. 3.1: TM100 Wiring Access

Loosen these two screws to open the display and access wiring terminals.

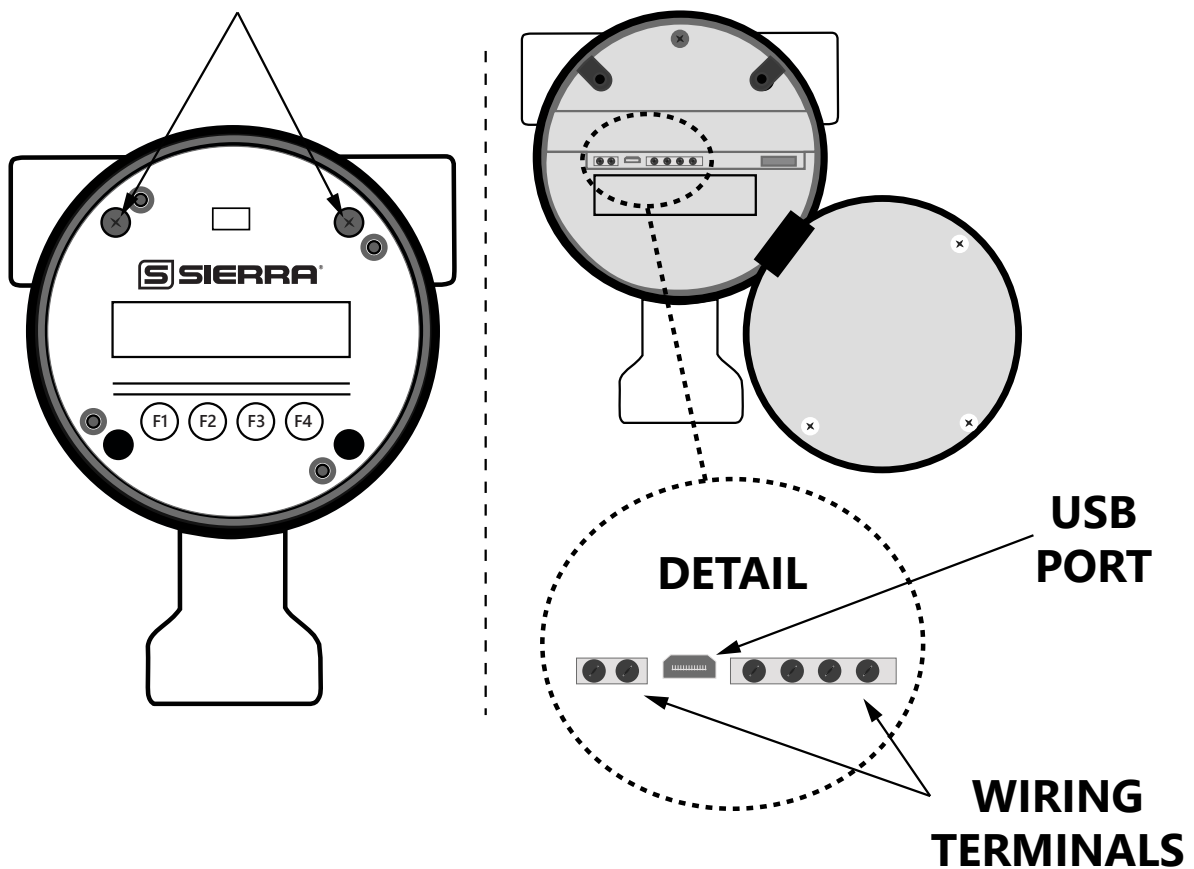

To wire the TM100, unscrew and remove the enclosure cap. Loosen the two captive screws on the display assembly and rotate it open to access the wiring terminals. Connect the power and signal wires to the terminal blocks according to the label and instructions on the following pages.

Cut all wires as short as allowable for a minimum service loop. Obtain the correct length for the TM100 wires using one of these methods:

- Trim the wires to extend 2 inches out of the enclosure after the conduit and wires are routed to the TM100.
- Trim the wires to extend 5 inches from the end of the conduit before attaching them to the TM100.

## Wiring Precautions

 **WARNING!** - DO NOT OPEN THE ENCLOSURE WHEN ENERGIZED OR AN EXPLOSIVE ATMOSPHERE IS PRESENT.

- All plumbing and electrical installations of flow meters must be in compliance with local codes, the end user's best engineering practices, and manufacturer's recommendations.
- Do not install the TM100 enclosure near an igniter, igniter-controller or switching equipment to eliminate the possibility of noise interference.
- Do not install an external power supply in a cabinet containing an igniter controller or switching equipment.
- This flow meter contains components that can be damaged by static electricity. You must discharge yourself by touching a grounded steel pipe or other grounded metal prior to working inside this flow meter.
- Close any unused conduit openings with suitable certified plugs

### Power Wiring

For wiring the 12 to 24VDC power, use stranded copper wire. Twisted pair shielded cable is recommended. Supply connection wiring must be rated for at least 90°C.

### Grounding

The enclosure must be properly grounded with a quality earth ground. 16 gauge, stranded wire is recommended. For US and Canada installation, the internal ground terminal on the enclosure must be used. Use of the external ground terminal is optional.

### Signal Wiring

For signal wiring the recommended wire gauge is 18 to 22 AWG. Always use twisted pair shielded cable. Cable shields should be connected to a good earth ground at one end only.

### Modbus and BACnet Serial Communication Wiring

A shielded 22 to 18 gauge three conductor cable is recommended for Modbus communication wiring. Two of the wires in the cable should be twisted pair and used for the Modbus transmit and receive signals. The third wire is for the Modbus common signal. The shield drain wire of the cable should be connected to chassis or earth ground at the Modbus modem. Belden number 3106A or a similar type of cable is recommended, depending on the environment or temperature requirements of the application.

**Power Input Requirements: 12 to 24VDC**

External DC power supply must provide 12 to 24VDC (10 to 30VDC full input power range) at 6 Watts minimum.

With 12VDC power, the TM100 can use up to 500mA. With 24VDC power, the TM100 can use up to 250mA.

A 20 Watt or greater power supply is recommended to ensure it can provide enough current under all temperature, ventilation, and power on conditions.

The enclosure must be properly grounded with a quality earth ground. Sixteen (16) gauge, stranded wire, is recommended for earth ground.

Connect the power wiring as shown in the diagram below.

Fig. 3.2: Connections for 12 to 24VDC Supply

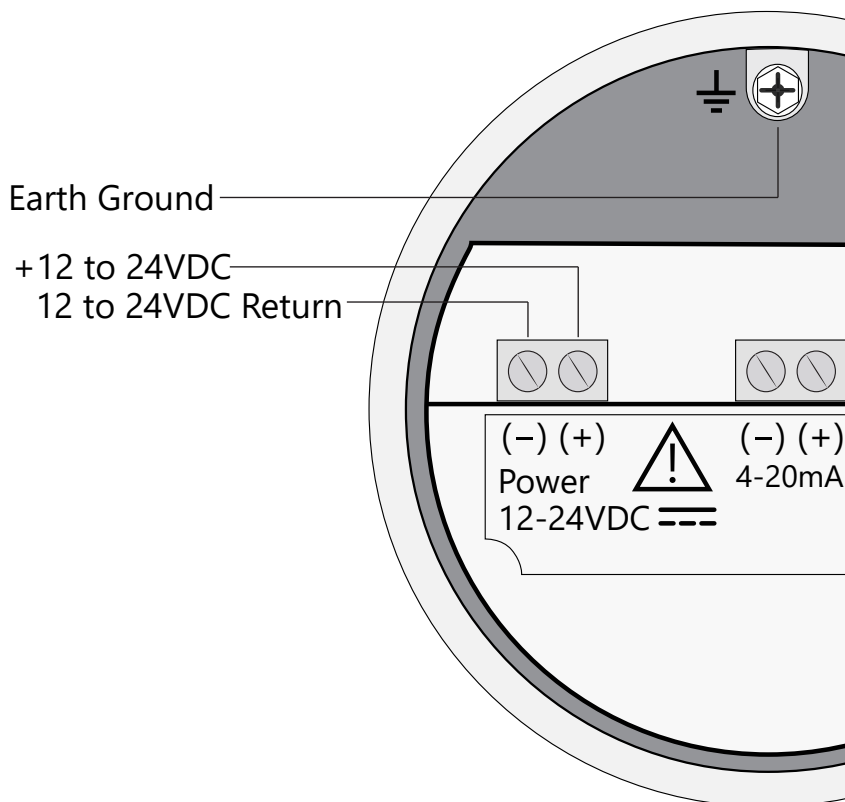
**CAUTION!**

- Supply connection wiring must be rated for at least 90°C.

### 4-20mA Output Wiring: Customer-Supplied Power Source (Recommended)

Bring the wiring in through either conduit hub. Connect the 4-20mA flow rate, 4-20mA temperature, and HART communication option wiring as shown in the diagram below.

Fig. 3.3: 4-20mA Output Wiring for Isolated Customer-Supplied Power Source

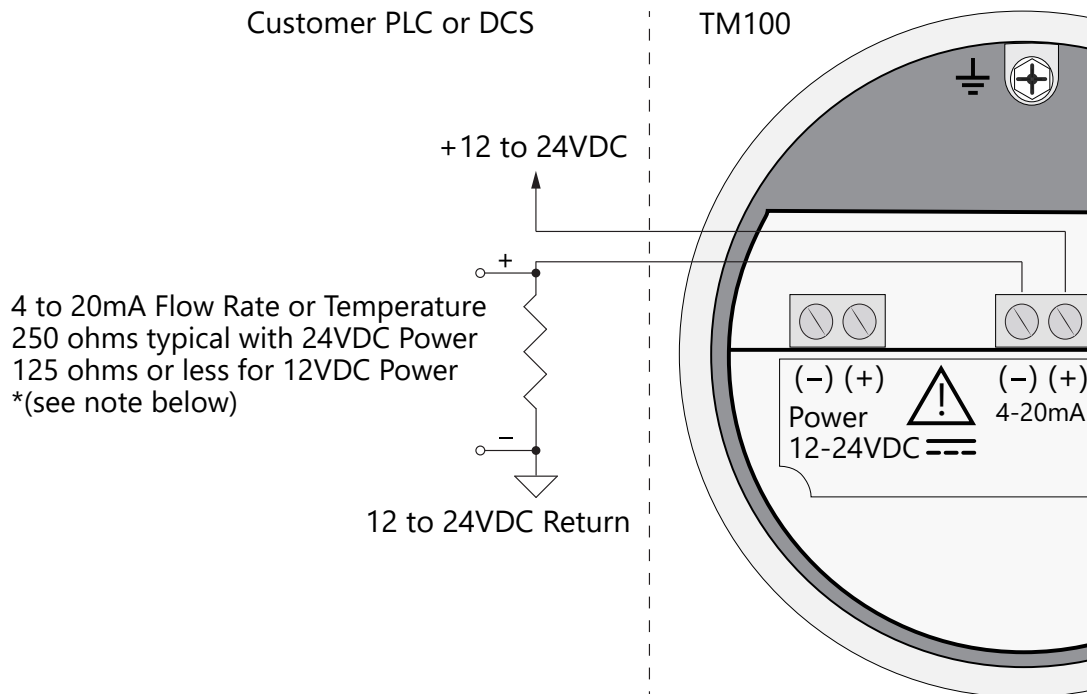

#### NOTE!

- When using a 12 volt power supply, the load resistor on the 4-20mA output must be 125 ohms or less to operate properly.
- When using 24 volt power, the load resistor is typically 250 ohms. A 250 ohm resistor in the 4-20mA circuit will result in a 1 to 5 volt signal to the PLC or DCS.
- When using a 24 volt power supply, the load resistor on the 4-20mA output must be 600 ohms or less.
- Some PLC and DCS equipment have built in load resistors, please refer to the technical manuals of such equipment.

### 4-20mA Output Wiring: Loop Power Provided by TM100

Bring the wiring in through either conduit hub. Connect the 4-20mA flow rate, 4-20mA temperature, and HART communication option wiring as shown in the diagram below.

Fig. 3.4: 4-20mA Output Wiring for Loop Power Provided by TM100

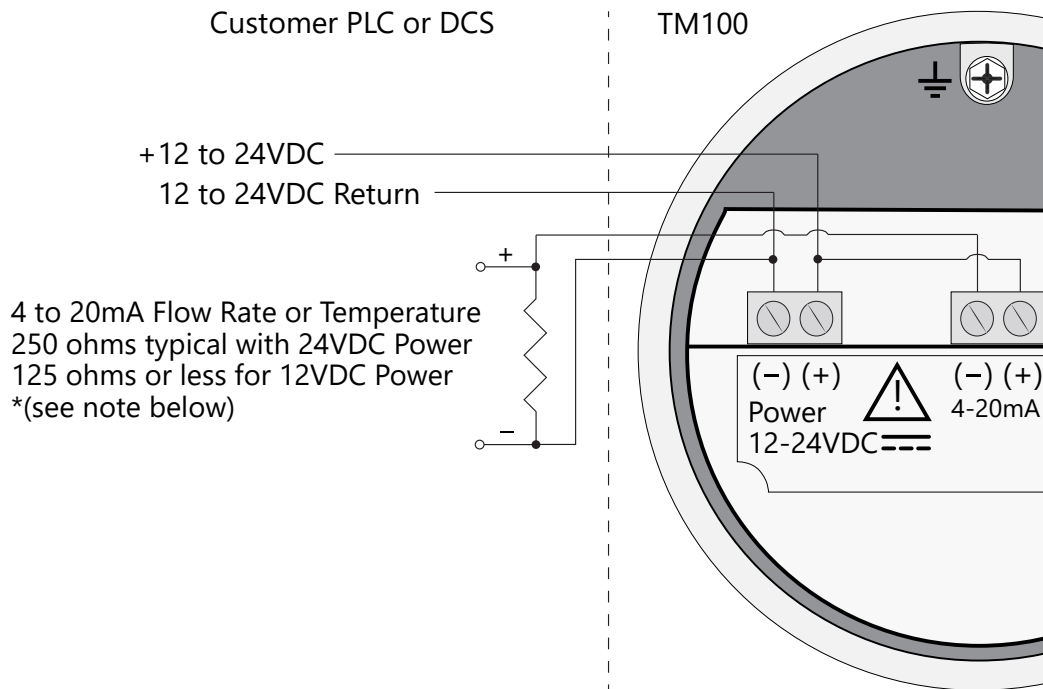

#### NOTE!

- When using a 12 volt power supply, the load resistor on the 4-20mA output must be 125 ohms or less to operate properly.
- When using 24 volt power, the load resistor is typically 250 ohms. A 250 ohm resistor in the 4-20mA circuit will result in a 1 to 5 volt signal to the PLC or DCS.
- When using a 24 volt power supply, the load resistor on the 4-20mA output must be 600 ohms or less.
- Some PLC and DCS equipment have built in load resistors, please refer to the technical manuals of such equipment.

### Pulse/Alarm Output Wiring: Customer Supplied Power Source (Recommended)

Bring Pulse/Alarm wiring in through either conduit hub. Connect the Pulse/Alarm wiring as shown in the diagram below. The Pulse/Alarm output is an open collector circuit capable of sinking a maximum of 20mA of current. Pulse or alarm selection is programmed using the display or TM100-View™. Only one option, pulse or alarm, can be active at a time.

Fig. 3.5: Pulse/Alarm Output Isolated (Recommended)

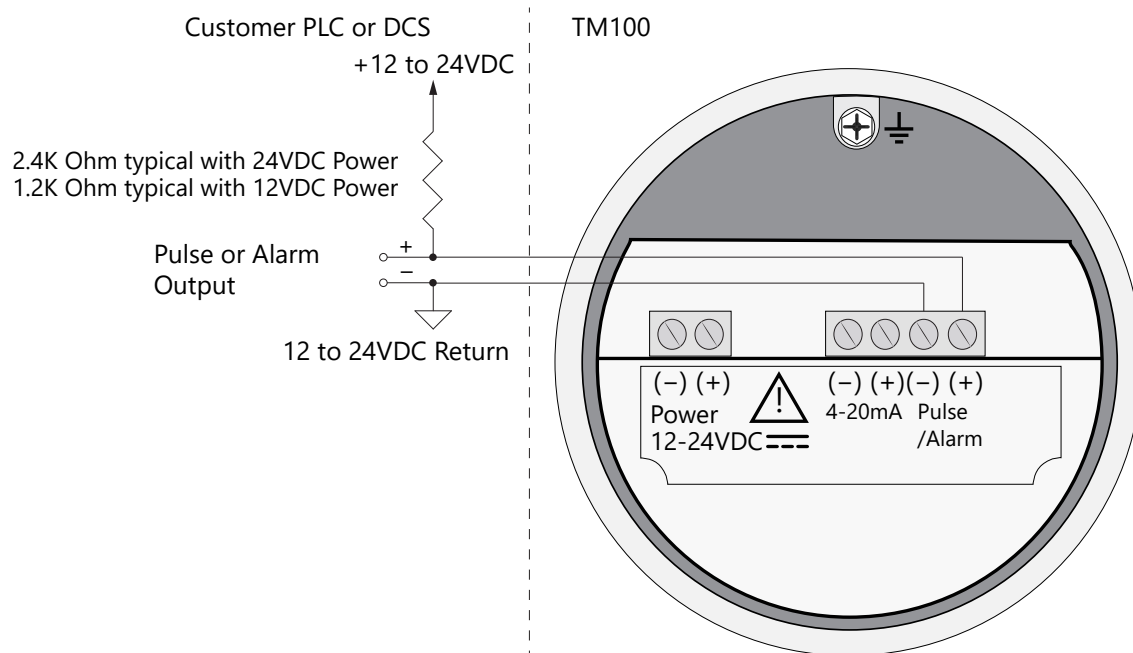

#### NOTE!

- The TM100 Pulse/Alarm output is typically used to drive digital circuitry or solid-state relays. The output of a solid state relay may, in turn, operate loads such as electromechanical relays or alarm indicators.
- The maximum load current of the Pulse/Alarm output is 20mA. Choose a load resistance that provides approximately 10mA with the power supply operating voltage.
- When the output is configured for Alarm and an alarm is not active, the output will be on (0 volts output). When an alarm is active, the output will be off (12 to 24 volts output).
- In order to use the Pulse/Alarm feature on the TM100, this feature must be chosen when the meter is ordered from the factory. Pulse output not available with meters ordered with Modbus RTU (RS485).



### Pulse/Alarm Output Wiring: Power Provided by TM100

Bring pulse/alarm wiring in through either conduit hub. Connect the pulse/alarm wiring as shown in the diagram below. The pulse/alarm output is an open collector circuit capable of sinking a maximum of 20mA of current. Pulse or alarm selection is programmed using the display or TM100-View™. Only one option, pulse or alarm, can be active at a time.

Fig. 3.6: Pulse/Alarm Output Power Provided by TM100

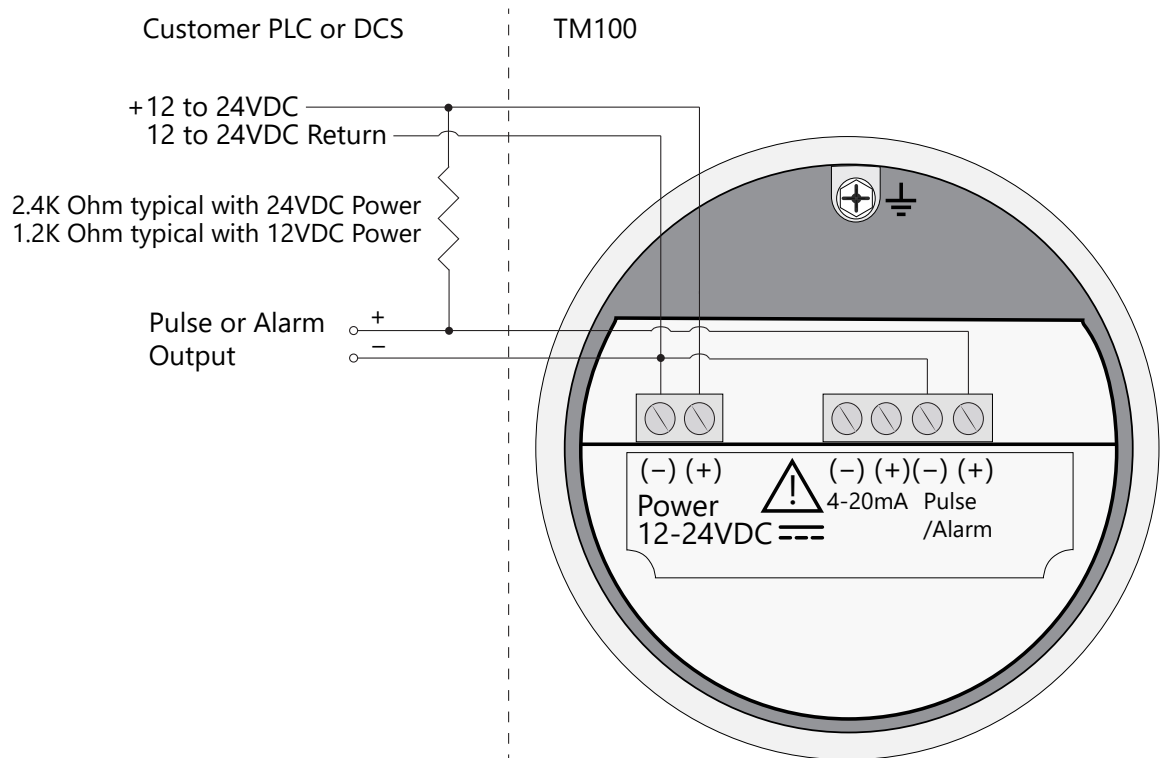

#### NOTE!

- The TM100 Pulse/Alarm output is typically used to drive digital circuitry or solid-state relays. The output of a solid state relay may, in turn, operate loads such as electromechanical relays or alarm indicators.
- The maximum load current of the Pulse/Alarm output is 20mA. Choose a load resistance that provides approximately 10mA with the power supply operating voltage.
- When the output is configured for Alarm and an alarm is not active, the output will be on (0 volts output). When an alarm is active, the output will be off (12 to 24 volts output).

**RS485 Wiring for Modbus RTU or BACnet MS/TP**

Wiring connections are made as shown in the diagram below for Modbus communication.

**Termination Resistor**

Connect a termination resistor across the receive/transmit signals of the last device on the communication line. To connect the 121 ohm termination resistor on the TM100, set jumper W1 to the Terminated position, see Fig. 3.7.

Disconnect the termination resistor on all other external RS485 devices. The termination resistor of the TM100 is disconnected by setting jumper W1 to the "open" position.

Fig. 3.7: RS485 Wiring

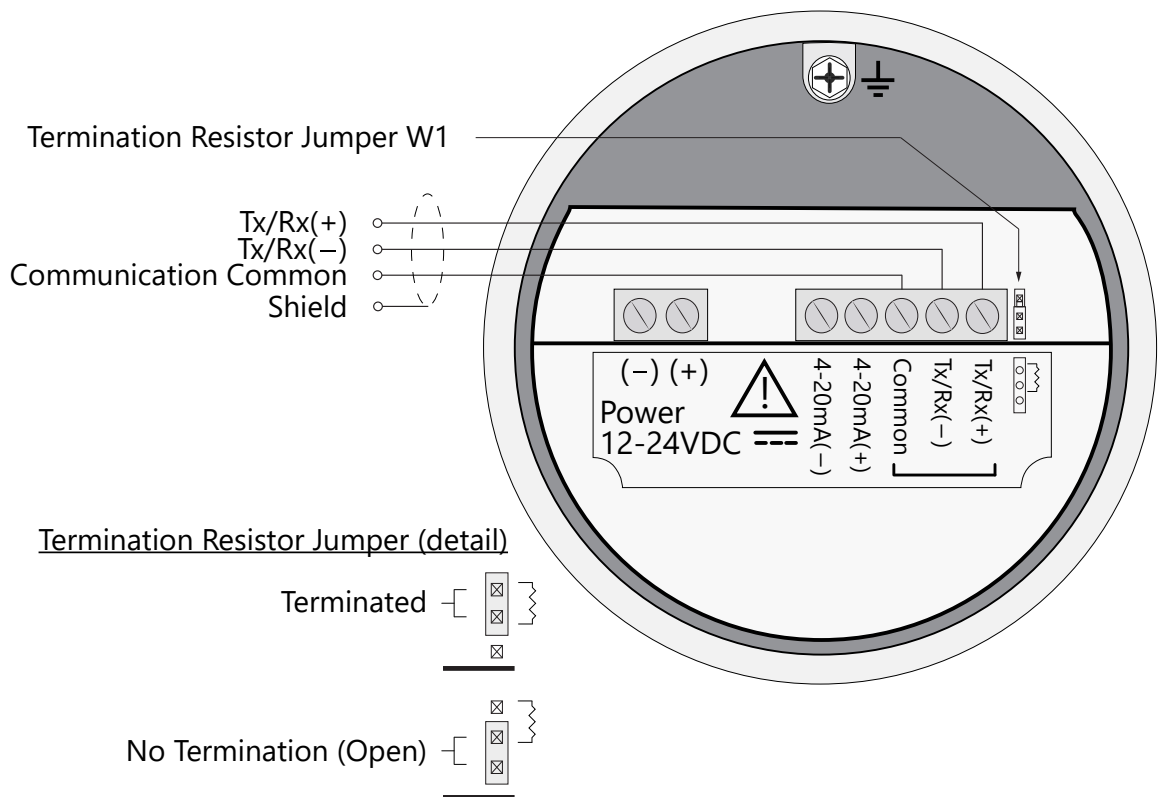

**NOTE!**

- In order to use the RS485 feature on the TM100, this feature must be chosen when the meter is ordered from the factory. Modbus RTU and BACnet MS/TP is not available with meters ordered with the Pulse/Alarm option.
- W1 jumper will either be in the open or terminated position. It should be in the terminated position on the last meter in the series.

## HART Wiring

The HART connections are made as shown in the diagram below.

**NOTE!** Meters ordered with HART will be configured for flow as default. If the customer changes the 4-20mA output to temperature, HART should report temperature.

### HART 4-20mA Output Wiring: Customer-Supplied Power Source

The 4-20mA current loop and HART modem connections are made as shown in the diagram below.

Fig. 3.8: HART Wiring, Customer-Supplied Power Source

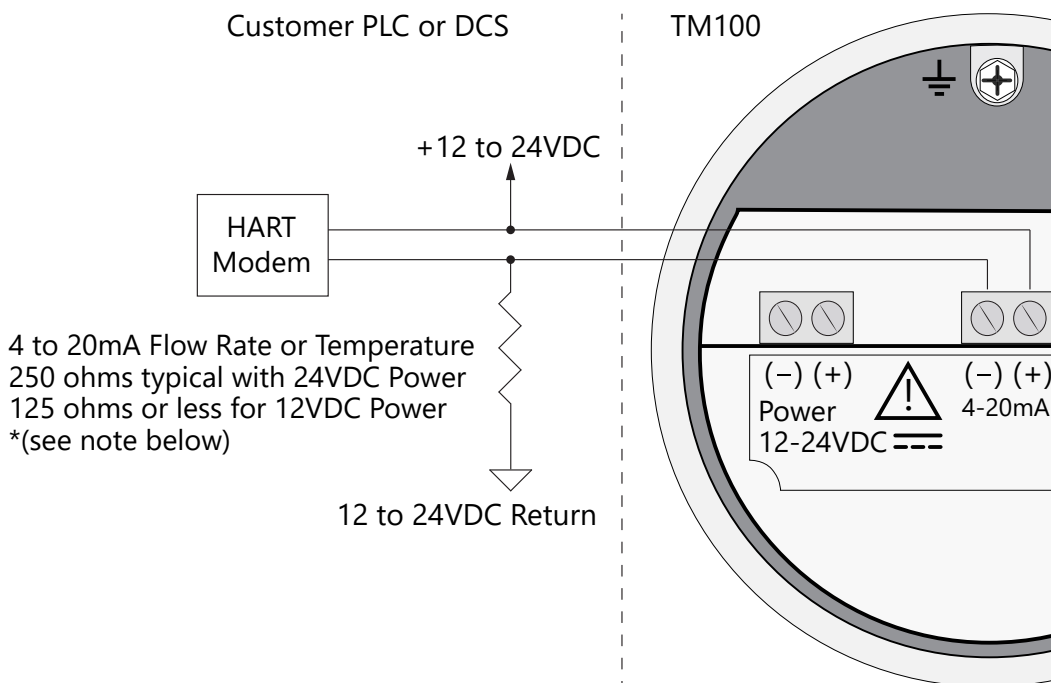

**NOTE!**

- When using a 12 volt power supply, the load resistor on the 4-20mA output must be 125 ohms or less to operate properly.
- When using 24 volt power, the load resistor is typically 250 ohms. A 250 ohm resistor in the 4-20mA circuit will result in a 1 to 5 volt signal to the PLC or DCS.
- When using a 24 volt power supply, the load resistor on the 4-20mA output must be 600 ohms or less.
- Some PLC and DCS equipment have built in load resistors, please refer to the PLC/DCS technical manual.

**HART 4-20mA Output Wiring: Handheld Communicator**

The 4-20mA current loop connections are made as shown in the diagram below.

A hand-held HART communicator can be connected to test points TP12 (+) and TP13 (-) with clip leads or to the 4-20mA terminal block.

Fig. 3.9: HART 4-20mA Output Wiring, Handheld Communicator

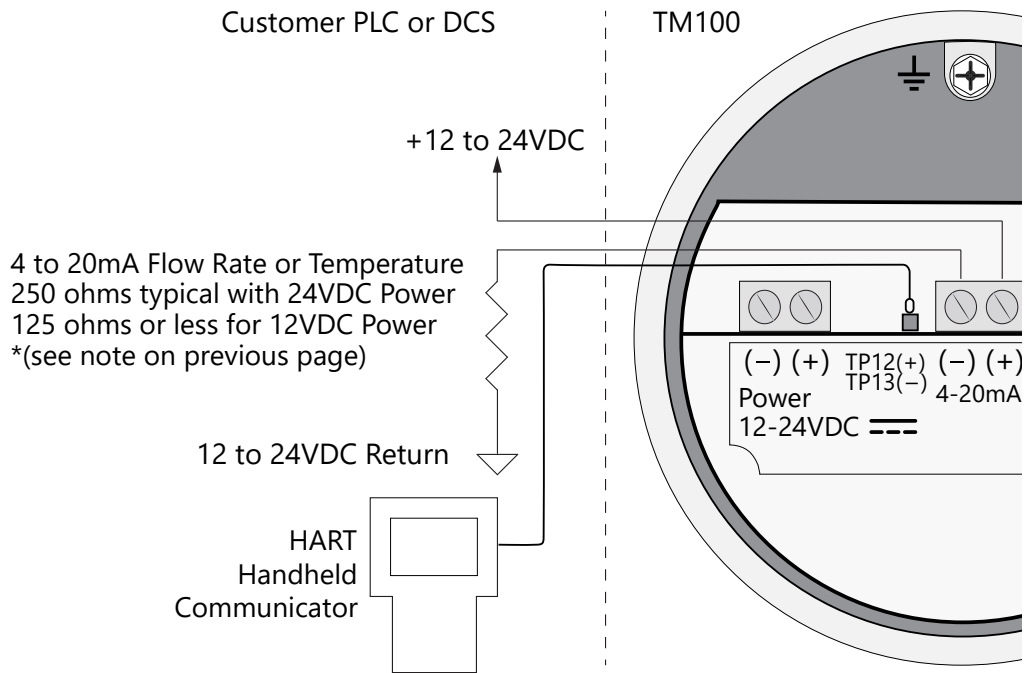

**HART 4-20mA Output Wiring: Loop Power Provided by TM100**

The 4-20mA current loop and HART modem connections are made as shown in the diagram below.

Fig. 3.10: HART 4-20mA Output Wiring, Loop Power Provided by TM100

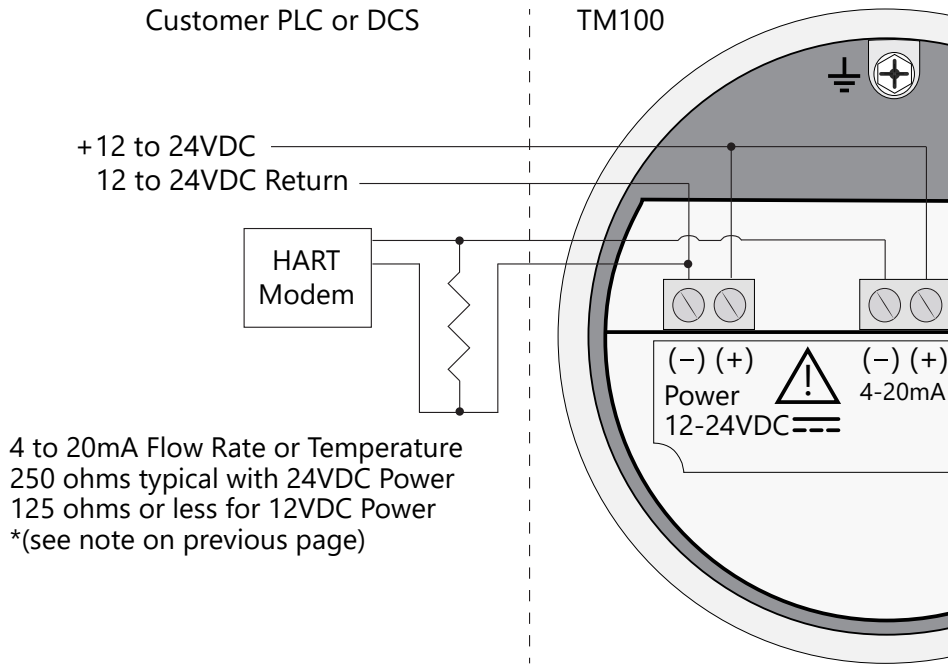

## Operations

### Start Up Sequence

The program automatically enters the Run/Measure mode after power up. The screen will show the software version of the TM100 during power up.

### USB Interface

The USB interface is a standard feature which allows communication with a PC to monitor readings and configure settings. The TM100-View™ software, is a free application program from Sierra Instruments that connects to the USB interface and allows data monitoring, configuration setting, data logging to Excel, and an option to save and recall TM100 configuration data.

### TM100 Display and Configuration Panel

The TM100 has an optional 2 line x 16 character display with four mechanical buttons. The meter can be programmed by using the display and configuration panel. The configuration panel can be accessed by removing the TM100 cap. Be sure to replace the cap after you are done configuring the TM100.

*Fig. 4.1: TM100 Optional Display and Configuration Panel*

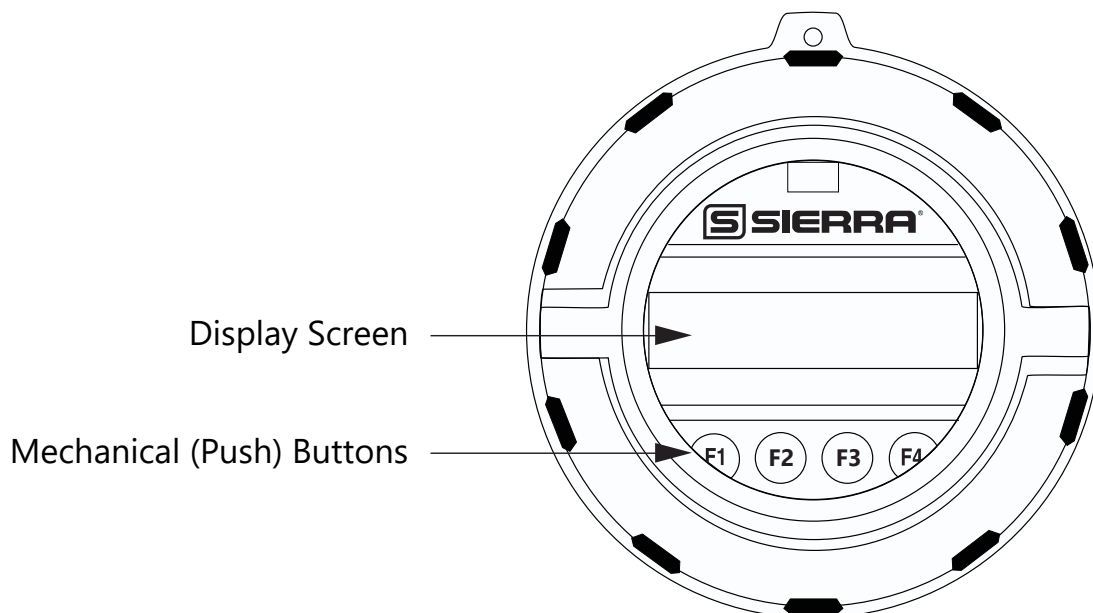

**Measurement Mode Display Screens**

In the measurement mode, there are four different display screens (Display 1, 2, 3 and a prompt screen to enter the programming mode). Two display screens are user programmable (refer to Display Setup p. 54). Scrolling through the display is accomplished by pressing the **F1** or **F2** key to view the next or previous screen.

Pressing the **F1** and **F2** keys at the same time enters the "Log Menu" and "Engineering Menu" screens (refer to p. 18).

Pressing the **F3** and **F4** keys at the same time brings up the "Reset Total" screen prompt.

Fig. 4.2: Measurement Mode Display Screen Navigation

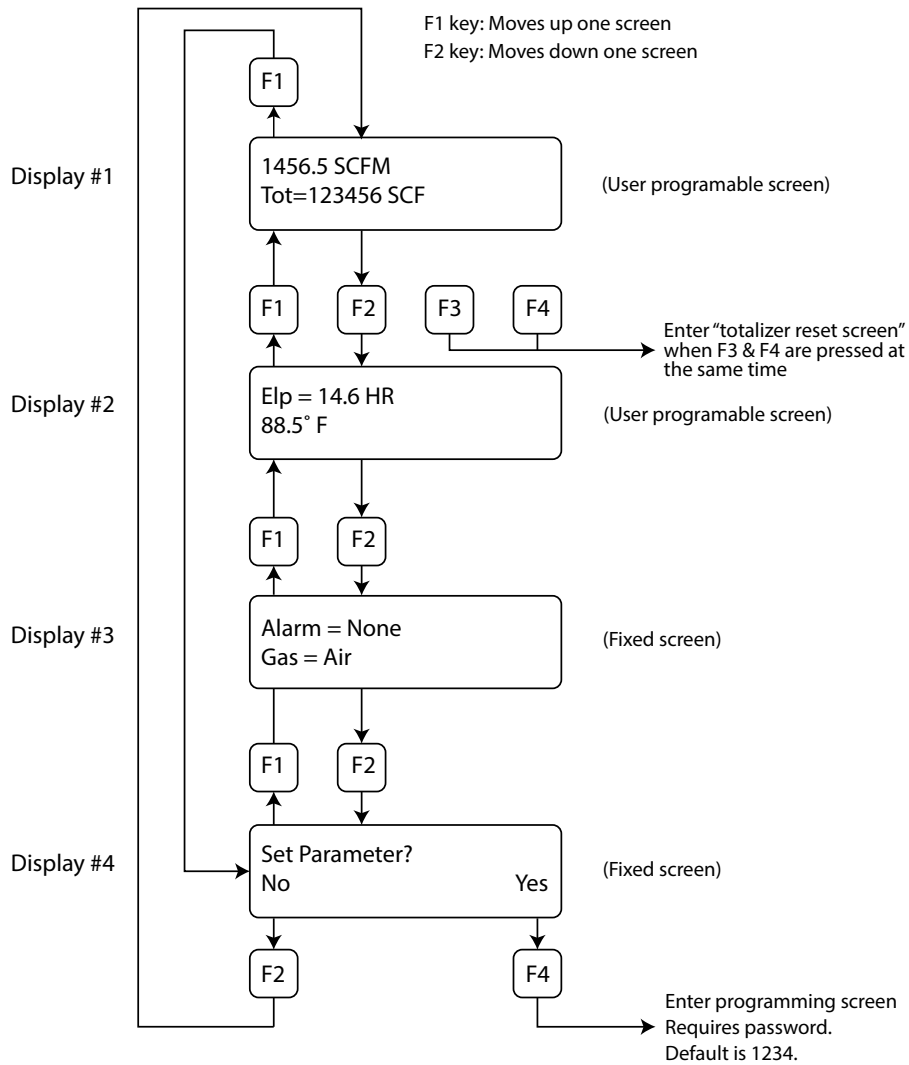

## Programming

### Data Entry using the Display and Configuration Panel

There are two basic types of menu entries: one for changing value or string and one for selecting from a selection list.

#### To Change a Value or String :

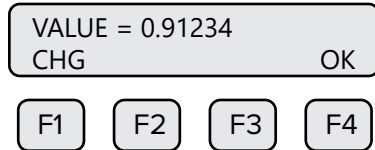

Press **CHG (F1)** key to change the value, **OK (F4)** to accept the value.

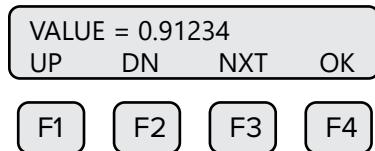

Press the **UP (F1)** or **DN (F2)** key to select a new digit or character, the cursor points to the selected digit. Press **NXT (F3)** to select the next digit and **OK (F4)** to accept the entry.

#### To Select from a List:

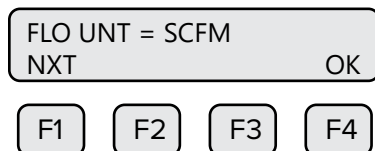

Press **NXT (F1)** key repeatedly until the correct selection is made and **OK (F4)** key to accept the entry.

### Entering the Programming Mode

To enter the programming mode and access the **Main Menu**, press the **F1** or **F2** key in the normal running mode until the following screen is shown:

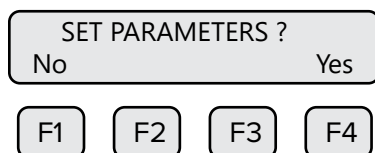

Press **YES (F4)** and the following screen will prompt user to enter password:

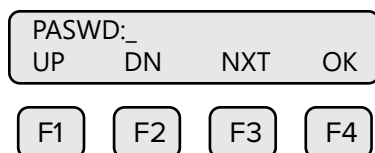



Enter the correct password, then follow the instructions for changing a value as specified above. The default Level 1 password is “1234”.

If the wrong password is entered, the message “Wrong Password” will display and then return to the programming entry screen.

**Main Menu**

If the password is accepted, the **Main Menu** screen will be shown:

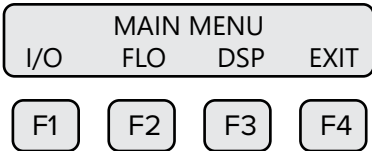

This is the Main Menu screen for the programming mode. Press **EXIT (F4)** repeatedly until “Normal Mode” is seen briefly to exit the programming mode.

**Analog 4-20mA Outputs**

The following menu allows the scaling of the analog 4-20mA output. From the Main Menu, press **I/O (F1)** to move to the 4-20mA output selection. In this screen press **420 (F3)** (screen appearance may vary according to options).

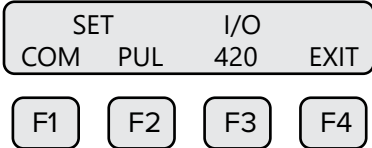

The 4-20mA output is programmable for flow or temperature:



Selections for the 4-20mA output are:

- Flow
- Temp

Select **NXT (F1)** to select Flow or Temperature and then press **OK (F4)**.

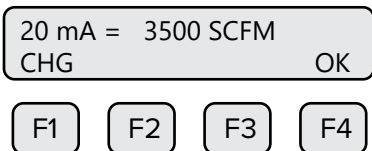

Enter the value for the 20mA and press **OK (F4)** key to accept the setting. Then the following screen will display:

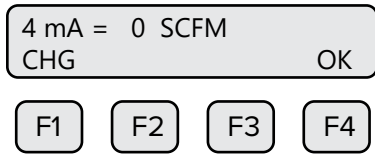

Enter the value for the 4mA and press **OK (F4)**.

**NOTE!** When the flow rate exceeds the programmed value for the 20mA set point, the analog output will stay at 20mA and an alarm code will be generated.

**NOTE!** 4mA is normally set to 0.

After setting the 4mA output value, choose the **mA Fault** value:

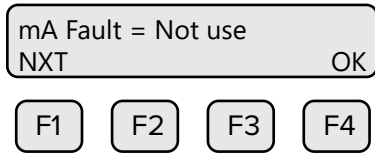

This menu allows the user to select an alarm fault level on the 4-20mA output. The alarm is activated when a serious issue is detected preventing the calculation of the correct flow rate. The 3.6mA and 21mA alarm outputs are related to the NAMUR NE 43 alarm feature.

The options are:

- mA Fault=3.6 mA (Force the 4-20mA signal to 3.6mA on alarm)
- mA Fault=21 mA (Force the 4-20mA signal to 21mA on alarm)
- mA Fault=Not use (4-20mA signal alarm fault not used)

The following events will set the output to 3.6mA or 21mA if the alarm level is selected:

- Sensor resistance above high limit
- Bridge Shutdown

Fig. 4.3: Range of 4-20mA Output and NAMUR Alarm

Press **(F4)** repeatedly until “Normal Mode” is seen briefly to exit the programming mode.

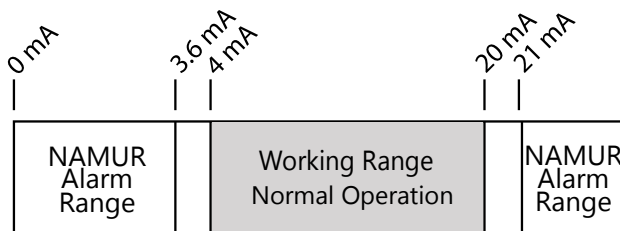

### Pulse/Alarm Output

The Pulse/Alarm feature can be accessed from the Main Menu, press **I/O (F1)**.

|         |      |
|---------|------|
| SET     | I/O  |
| OUT INP | EXIT |

F1 F2 F3 F4

Press **OUT (F1)** to select the pulse output. The following screen will show:

|             |    |
|-------------|----|
| OUT = Pulse | OK |
| NXT         |    |

F1 F2 F3 F4

Press **NEXT (F1)** to cycle through output options until you have the selection for "OUT=Pulse" and press **OK (F4)**.

The pulse output can be configured in one of three ways:

1. Specifying how many pulses per unit, P/U (i.e., 10 pulses per SCF)
2. Specifying how many flow units total per pulse, U/P (i.e., 0.1 SCF per pulse)
3. Specifying a maximum frequency to a defined maximum value of flow rate

All of these approaches are equivalent.

|                  |
|------------------|
| PULSE OUTPUT     |
| P/U U/P FEQ EXIT |

F1 F2 F3 F4

Use **P/U (F1)** to enter pulse per unit, **U/P (F2)** for unit per pulse or **FEQ (F3)** to enter the flow and maximum frequency to scale the Pulse/Alarm output.

**NOTE!** When data is entered with any of the three described methods, the other values will be recalculated according to the settings.

### Entering data in Pulse per Unit:

From the Pulse/Alarm Output Menu above, press **P/U (F1)** and the following screen will show:

|             |    |
|-------------|----|
| PLS/UNT = 2 | OK |
| CHG         |    |

F1 F2 F3 F4

Press **CHG (F1)** to change the setting and then **OK (F4)** to accept entry.

The value entered is in pulse per selected flow unit total (i.e., 2 pulses per SCF).

**Entering data in Unit per Pulse:**

From the Pulse/Alarm Output Menu, press **U/P (F2)** and the following screen will show:



Press **CHG (F1)** to change the setting and then **OK (F4)** to accept entry. The value entered is in unit per pulse (i.e. 0.5 flow unit total per pulse)

**Entering data with flow and maximum frequency:**

From the Pulse/Alarm Output Menu, press **FEQ (F3)** and the following screen will show:

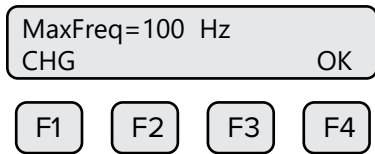

Enter the maximum pulse rate (frequency) and press **OK (F4)**.

**CAUTION!** Maximum pulse rate (frequency) cannot exceed 100 Hz.

The next screen will show:

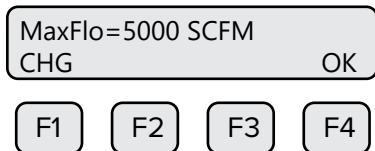

**NOTE!** If the flow rate exceeds the maximum pulse rate (frequency), the output will stay at 100 Hz and the TM100 will issue an alarm code.

**Alarm Output**

To access the Pulse/Alarm feature, press **I/O (F1)** key from the **Main Menu** screen.

The screen will show:

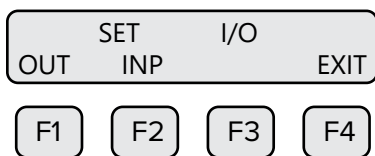

Then press **OUT (F1)** and the screen may show:



Then press **NXT (F1)** to select the correct alarm and press **OK (F4)**.

Selections are:

- Not used
- Pulse
- HiFloAlm = High Flow Alarm
- LoFloAlm = Low Flow Alarm
- HiTempAlm = High Temperature Alarm
- LoTempAlm = Low Temperature Alarm
- System Alarm

When the output is set to Alarm and there is no alarm condition, the output will be on (0 volts). When an alarm is active, the output is turned off (12 to 24 volts).

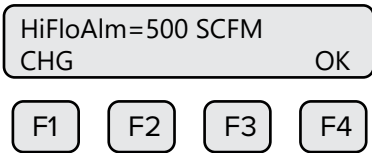

Enter the value for the limit by pressing **CHG (F1)** and then **OK (F4)**. A value of zero (0) disables the alarm.

**NOTE!** There is only one output to operate as a pulse output or an alarm output. Both cannot operate at the same time.

**Serial Communication Settings**

If RS485 Communication feature was purchased, the Serial communication settings can be programmed by pressing **I/O (F1)** key from the Main Menu. The screen will show:

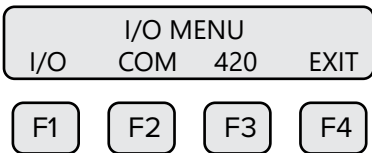

Press **COM (F2)** to select Serial communication.

The screen may show:

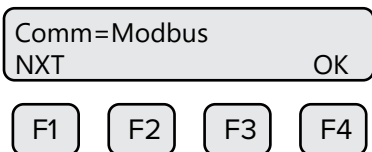

Options for serial communication are:

- None
- Modbus
- BACnet
- HART

**NOTE!** Any selection other than “None” requires the communication option for the selected communication type. If enabling a communication option, see the Communications Protocols section of this manual.

**Display Setup**

There are four display screens that you can cycle through in normal operating mode (see Figure 4.2 on p. 47). Two of the four display screens are fixed and cannot be changed (Displays #3 & 4). The other two screens are programmable to show the information that you prefer.

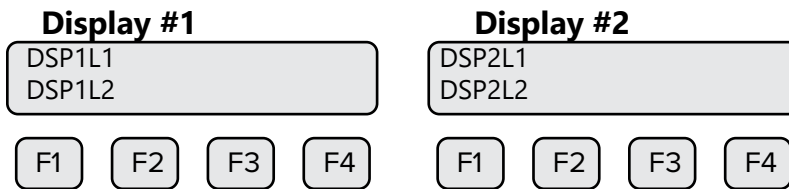

Selections are:

- DSP1L1 = Display 1, Line 1
- DSP1L2 = Display 1, Line 2
- DSP2L1 = Display 2, Line 1
- DSP2L2 = Display 2, Line 2

**To Program Display Screens #1 & 2:**

From the Main Menu press **DSP (F3)** to select the display menu:

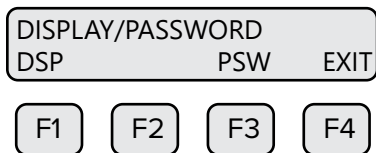

Press **DSP (F1)** key. The display will show:

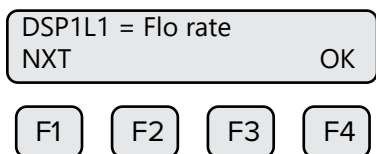

These are the selections for the "Display 1, Line 1".

Selections are:

- Flo rate = Flow rate
- Total = Total mass or volume
- Elps = Elapsed time
- Temp = Temperature
- Alarm = Error codes

When the selection is correct, press **OK (F4)** to accept. The display will then go through the same process for all four lines of the two programmable displays (DSP1L1, DSP1L2, DSP2L1 and DSP2L2). After the last line of Display 2 is accepted, the display will show the following menu:

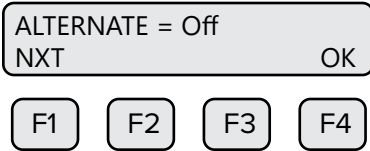

This menu allows you to alternate between menu display 1 and 2 every few seconds.  
Selections are: On or Off

Press **OK (F4)** to accept selection. Press **EXIT (F4)** repeatedly until “Normal Mode” is seen briefly to exit the programming mode.

### Password

There are two user level passwords, only **Level 1** is programmable and gives access to all the normal settings. The second password is used to allow access to calibration settings.

Default **Level 1** password is “1234,” and **Level 2** password is “9111.” The **Level 1** programmable password can be disabled by setting it to “0.”

From the Main Menu press **DSP (F3)** to select the display menu.

### To Program the Password:

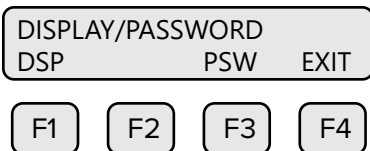

Press **PSW (F3)** key to select password.

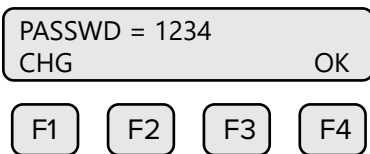

This screen displays the current **Level 1** password.  
Press **CHG (F1)** key to change the password and enter new value.

Press **OK (F4)** to accept new data and exit programming by pressing **EXIT (F4)** key repeatedly until out of the programming mode.

**NOTE!** Password can be number or letter characters up to four digits.

### Units Settings Menu

This menu is used to set the units for flow, temperature, and pressure as well as the setting of reference temperature and reference pressure.

These values will be set at Sierra Instruments using information supplied by the customer. These values can be changed to match a new application. The units setting is accessed from the **Main Menu**. To access the **Unit Settings Menu**:

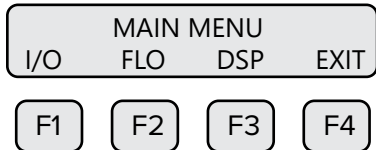

Press **FLO (F2)**:

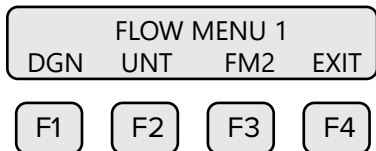

Press **UNT (F2)** for Unit selection.

The screen will show:

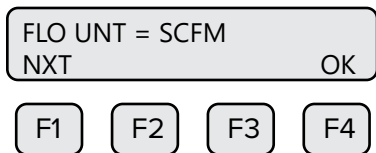

Press **NXT (F1)** to change selection and **OK (F4)** to accept.

**NOTE!** The totalizer (total flow measured) will roll over when reaching a certain value. The maximum value is dependent on the flow units selected (see Totalizer Rollover p. 63).

### Flow Units

Selections for flow units are:

|       |       |       |       |                |
|-------|-------|-------|-------|----------------|
| SCFM  | KG/M  | LBS/D | SM3/H | MSCFD (MCFD)   |
| SCFH  | KG/S  | NLPH  | SM3/D | MMSCFD (MMCFD) |
| NM3/H | LBS/H | NLPM  | NM3/D | MCFD (MSCFD)   |
| NM3/M | LBS/M | NLPS  | SLPM  | MMSCFM (MMCFM) |
| KG/H  | LBS/S | SM3/M | SCFD  | MT/H           |

**WARNING!** The TM100 re-calculates area, 4 and 20mA values, maximum flow for the pulse output and flow cutoff when changing flow units.



### Temperature Units

After pressing **OK (F4)** to accept the Flow unit the display will prompt for the temperature unit setting:

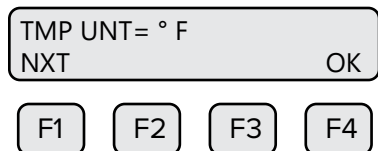

Press **NXT (F1)** to change selection and **OK (F4)** to accept.

Selections for Temperature units are: °C or °F.

### Reference Temperature

After pressing **OK (F4)** to accept the temperature unit setting, the display will prompt for temperature reference in selected unit.

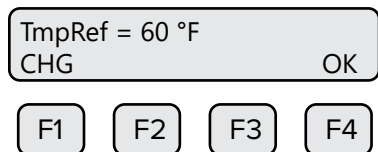

Press **CHG (F1)** to change the reference and **OK (F4)** to accept.

### Pressure Units

After pressing **OK (F4)** to accept the reference temperature, the display will prompt for the reference pressure unit selection:

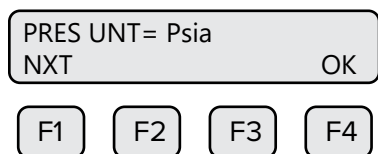

Press **NXT (F1)** to select next entry and **OK (F4)** to accept.

Selections are:

mmHG = Millimeters of mercury (absolute)

Psia = Pounds per square inch absolute

bara = Bar absolute

### Reference Pressure

After the pressure unit selection is made, the display will show a menu to enter the reference pressure:

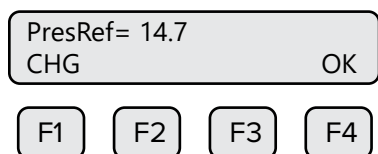

Press **CHG (F1)** to change it and **OK (F4)** to accept.

## Accessing Flow Parameters and Alarm Settings

This is the menu used to set various flow parameter values. They are: flow cutoff, pipe diameter, filter, high and low alarm for flow and temperature.

**NOTE!** The parameters in this menu are set to the customer specifications at the factory. They should only be changed when changing the application of the flow meter.

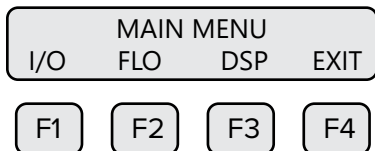

The menu is accessed from the Main Menu by pressing **FLO (F2)**:

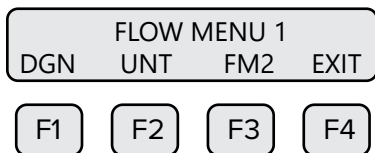

Then press **FM2 (F3)**:

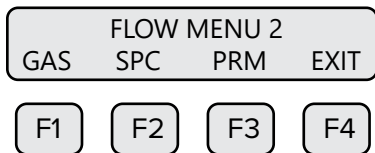

**NOTE!** The SPC function key will only appear and be accessible from a Level 2 password.

Then press **PRM (F3)**. This will move into settings for flow cutoff, pipe diameter, and filter value. These settings will be followed by the high and low alarm settings for flow rate and/or temperature.

## Programming Flow Parameters

### Flow Cutoff

The first parameter is Flow Cutoff:

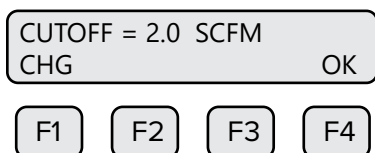

Enter the value for the flow cutoff and then press **OK (F4)**. When the flow rate falls below the flow cutoff, the flow meter will display a flow value of zero.

## Pipe Diameter

|                           |    |    |    |
|---------------------------|----|----|----|
| Pipe_id = 3.068 In<br>CHG | OK |    |    |
| F1                        | F2 | F3 | F4 |

To set the pipe Diameter, enter the pipe diameter in inches or **millimeters** and then press **OK (F4)**. Use millimeters for metric flow unit selections and inches for English flow unit selections. This selection is dependent on the flow unit selected (English vs metric). If the pipe/duct is a square or rectangle, the hydraulic diameter (equivalent value for a round pipe) must be entered for the pipe ID.

## Filter Value

The filter value is entered in seconds. The allowable time constant range is 0.8 to 10 seconds. The filter time interval is proportional to the dampening.

Enter the filter value and then press **OK (F4)**.

|                         |    |    |    |
|-------------------------|----|----|----|
| FILTER = 0.8 sec<br>CHG | OK |    |    |
| F1                      | F2 | F3 | F4 |

## Programming High and Low Alarm Settings

Settings for the alarms directly follow the flow parameters for flow cutoff, pipe diameter, and filter value. These alarms can be used without the digital output assigned to the alarm. If that is the case, the alarm status will only be shown on the display, through serial communication, or TM100-View™. If the digital output is assigned to an alarm, changing the value here will change that setting.

## High Flow Rate Alarm

This is the upper flow limit alarm value that can be associated with the alarm output. An alarm code is generated when the flow value exceeds this limit. If no alarm is needed, set this value to zero.

To set the parameters for a high flow rate alarm, press **CHG (F1)**:

|                             |    |    |    |
|-----------------------------|----|----|----|
| HiFloAlm = 1234 SCFM<br>CHG | OK |    |    |
| F1                          | F2 | F3 | F4 |

Press **OK (F4)** to accept the value.

### Low Flow Rate Alarm

This is the lower flow limit alarm value that can be associated with the alarm output. An alarm code is generated when the flow value is below this limit. If no alarm is needed, set this value to zero.

To set the parameters for a low flow rate alarm, press **CHG (F1)**:

|                     |    |
|---------------------|----|
| LoFloAlm = 100 SCFM | OK |
| CHG                 |    |

F1 F2 F3 F4

Press **OK (F4)** to accept the value.

### High Temperature Alarm

This is the upper temperature limit alarm value that can be associated with the alarm output.

An alarm code is generated when the temperature value exceeds this limit. If no alarm is needed, set this value to zero.

To set the parameters for a high temperature alarm, press **CHG (F1)**:

|                  |    |
|------------------|----|
| HiTmpAlm = 200 F | OK |
| CHG              |    |

F1 F2 F3 F4

Press **OK (F4)** to accept the value.

### Low Temperature Alarm

This is the lower temperature limit alarm value that can be associated with the alarm output. An alarm code is generated when the temperature value is below this limit. If no alarm is needed, set this value to zero.

To set the parameters for a high temperature alarm, press **CHG (F1)**:

|                 |    |
|-----------------|----|
| LoTmpAlm = 20 F | OK |
| CHG             |    |

F1 F2 F3 F4

Press **OK (F4)** to accept the value.

### Simulation

This menu allows for simulation of flow rate and temperature. It should only be used for testing and demonstration purposes. **Make sure to return all of these simulation values to zero, before returning to the normal mode of operation.**

**CAUTION!** If the 4-20mA and/or the Pulse/Alarm outputs are connected to controllers, set the controllers to “manual” to ensure that the simulated signals do not cause false controller action.

The menu is accessible from the "Main Menu" by pressing **FLO**:

|             |     |     |      |
|-------------|-----|-----|------|
| FLOW MENU 1 |     |     |      |
| DGN         | UNT | FM2 | EXIT |
| F1          | F2  | F3  | F4   |

Pressing **DGN (F1)** will show:

|            |        |      |    |
|------------|--------|------|----|
| DIAGNOSTIC |        |      |    |
| SIM        | TM-Cal | EXIT |    |
| F1         | F2     | F3   | F4 |

Pressing **SIM (F1)** will show:

|                |    |    |    |
|----------------|----|----|----|
| Simulate Flow? |    |    |    |
| YES            | NO |    |    |
| F1             | F2 | F3 | F4 |

Press **YES (F1)** to continue.

|                 |    |    |    |
|-----------------|----|----|----|
| FloSim = 0 SCFM |    |    |    |
| CHG             | OK |    |    |
| F1              | F2 | F3 | F4 |

Enter the value and then press **OK (F4)**.

**NOTE!** Enter zero to disable this feature.

|                |    |    |    |
|----------------|----|----|----|
| Simulate Temp? |    |    |    |
| YES            | NO |    |    |
| F1             | F2 | F3 | F4 |

Press **YES (F1)** to continue.

|              |  |    |
|--------------|--|----|
| TmpSim = 0 C |  | OK |
| CHG          |  |    |

F1   F2   F3   F4

Enter the value and then press **OK (F4)**. Enter zero to disable this feature.

|             |  |    |
|-------------|--|----|
| ENABLE SIM? |  | NO |
| YES         |  |    |

F1   F2   F3   F4

Press **YES (F1)** to start the simulation mode, otherwise press **NO (F4)**. Upon pressing either key, the program will return to the FLOW MENU 1 screen.

**NOTE!** Simulation Mode will be cleared if the power is cycled.

### K Factor

The K Factor allows the user to adjust the meter's calibration. The Sierra Instruments flow meter increases the calculated flow rate by the K Factor. This results in a direct scaling of the meter's output across the entire full range.

The K Factor parameter is accessed from the "Flow Menu 2" menu by entering a **Level 2** password "9111" and pressing the **SPC** key (**F2**).

|             |     |     |      |
|-------------|-----|-----|------|
| FLOW MENU 2 |     |     |      |
| GAS         | SPC | PRM | EXIT |

F1   F2   F3   F4

The following screen will be displayed:

|           |  |    |
|-----------|--|----|
| K fact=0% |  | OK |
| CHG       |  |    |

F1   F2   F3   F4

Press **CHG (F1)**. Add the correction factor and press **OK (F4)**.

If you want the flow meter to read 5% higher, enter 5.0%.

If you want the flow meter to read 5% lower, enter -5.0%.

If an existing K Factor is present, add the additional K Factor to the existing value.

Upon pressing **OK (F4)**, an option to restore the database will follow.

### Restore Database

In case of user error, the ability to restore the meter to the original factory settings can be achieved in this menu. The display will show:

|                   |    |
|-------------------|----|
| RESTORE DATABASE? |    |
| YES               | NO |
| F1                | F2 |
| F3                | F4 |

Press **YES (F1)** ONLY if you want to restore your database to the initial factory setting that the meter was shipped with. All current user-entered settings will be overwritten. The green LP3 LED will flash at a faster pace until the recall is performed. The "RESET CRC" screen will follow "RESTORE DATABASE". Upon pressing **OK (F4)**, an option to reset the NVRAM CRC will follow.

### Reset CRC

If the NVRAM CRC check fails (Error Code 36), the programmed settings values will need to be verified and corrected before clearing the error. Call Sierra Instruments Customer Service if you need assistance.

|            |    |
|------------|----|
| RESET CRC? |    |
| YES        | NO |
| F1         | F2 |
| F3         | F4 |

Press **YES (F1)** ONLY if you want to reset the CRC and generate a new CRC value.

### Reset Total and Elapsed Time

Enter the flow totalizer and elapsed time screen by pressing the **F3** and **F4** keys at the same time in the normal running mode.

|               |     |
|---------------|-----|
| RESET TOTAL ? |     |
| NO            | YES |
| F1            | F2  |
| F3            | F4  |

Press **YES (F4)** and enter password to reset total and elapsed time. Press **NO (F1)** to cancel.

**NOTE!** This feature is not available on non-resettable units.

Totalizer Rollover: The TM100 has an automatic roll-over function. The total flow count of the TM100 will roll over after 99,999,999,999. Except for:

|         |             |
|---------|-------------|
| MSCFD:  | 999,999,999 |
| MMSCFM: | 9,999,999   |
| MMSCFD: | 999,999     |

### Calibration of the Sierra Instruments TM100 Thermal Flow Meter

To ensure that all Sierra Instruments flow meters meet specified performance parameters and provide accurate, repeatable measurements in the field, all calibrations are performed with NIST-traceable flow standards. Each meter is shipped from the factory with a Sierra Instruments Calibration Certificate.

### TM-Cal™ Calibration Validation Test

Sierra Instruments has developed the TM-Cal™ Calibration Validation test to help our customers avoid sending the meter back for annual or biennial recalibration.

TM-Cal™ ensures the repeatability, functionality of the sensor and its associated signal processing circuitry. By performing a simple test, the operator can verify that the meter is running accurately.

During the TM-Cal™ calibration validation test, the microprocessor adjusts current to the sensor elements and determines the resulting electrical characteristics. Data within established tolerances confirms the meter is accurate.

### Recommended Conditions for Performing TM-Cal™ Test

Sierra Instruments recommends the TM-Cal™ test be run under flowing conditions, especially in smaller pipe sizes. If the TM-Cal™ test does not produce a "PASS" result, refer to "TM-Cal™ Test Results" on page 66.

**NOTE!** If the TM-Cal™ test is performed using the Sierra Instruments TM100-View™ software, at the completion of the test, a TM-Cal™ Certificate may be printed for a record of the test. This certificate will display a pass/fail result.

### Performing the TM-Cal™ Calibration Validation Test

Press **FLO (F2)** from the "Main Menu." The display will show:

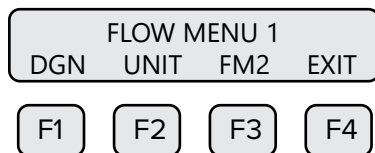

Press **DGN (F1)**. The display will show:

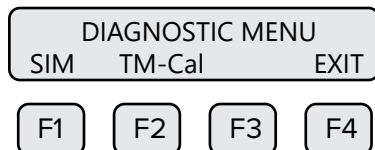



Press **TM-Cal (F2)**. The display will show:

|             |    |      |
|-------------|----|------|
| TM-Cal MENU |    |      |
| VER         |    | EXIT |
| F1          | F2 | F3   |
|             | F4 |      |

Press **VER (F1)** to perform the TM-Cal™ verification test.

|                |    |    |
|----------------|----|----|
| VERIFY TM-Cal? |    |    |
| YES            |    | NO |
| F1             | F2 | F3 |
|                | F4 |    |

Press **OK (F4)** to continue.

|                 |      |    |
|-----------------|------|----|
| Flo: Hold value |      |    |
| NXT             | EXIT | OK |
| F1              | F2   | F3 |
|                 | F4   |    |

Press **NXT (F1)** to toggle between "Hold value" and "Go to zero." During the TM-Cal test, "Hold value" will keep the flow 4-20mA and Pulse outputs at the last value measured. "Go to zero," during the TM-Cal test will set the flow 4-20mA and Pulse outputs to the equivalent of zero flow..

|                 |      |    |
|-----------------|------|----|
| Flo: Go to zero |      |    |
| NXT             | EXIT | OK |
| F1              | F2   | F3 |
|                 | F4   |    |

Press **OK (F4)** to continue with the TM-Cal test..

**!** **WARNING!** If you are using closed loop control, the system needs to be taken off-line during the test.

|              |      |    |
|--------------|------|----|
| Take Control |      |    |
| off-line     | EXIT | OK |
| F1           | F2   | F3 |
|              | F4   |    |

This screen verifies that the user is ready to begin the TM-Cal test and that the 4-20mA and Pulse outputs will not be operating normally.

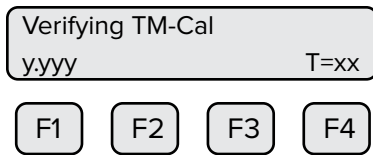

This test takes about 3 minutes (200 seconds). During the test, the display will show the TM-Cal™ value changing as the power to the sensor is adjusted. "T=xx" is a TM-Cal™ timer indicating how much time is left to finish the test.

### TM-Cal™ Test Results

Upon test completion, the final TM-Cal™ value will be displayed along with a "Pass," "Fail," or "Warning" message:

- Pass: less than  $\pm 0.80$
- Warning: between  $\pm 0.80$  to  $\pm 1.0$
- Fail: greater than  $\pm 1.0$

Recommended next steps if a "Warning" or "Fail" result is displayed:

- Run the test again under a higher flow rate if possible.
- Remove the probe from the pipe, clean the sensor, and perform the test again under a normal or high flow rate.

If a "Warning" or "Fail" result is displayed after repeating the test, please call Sierra Customer Service at (831) 373-0200 for assistance.

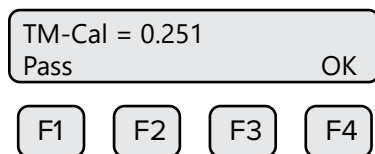

Press **OK (F4)** to exit the menu when the test is complete.

### Available Gases and Gas Mixes through Gas-Mix™

This menu allows the user to select a gas or Gas Mix from a pre-calibrated list of gases available on the Sierra Instruments TM100 flow meter. Gases available in the Gas-Mix™ feature include:

- |                        |           |               |
|------------------------|-----------|---------------|
| • Methane              | • Argon   | • Hydrogen    |
| • Carbon Dioxide (CO2) | • Propane | • Ethane      |
| • Nitrogen             | • Helium  | • 5-Gas Mix** |
| • Air                  | • Oxygen  |               |
| • Natural Gas*         | • Butane  |               |

\*Natural gas is defined as NAESB natural gas mix (94.9% Methane, 2.5% Ethane, 1.6% N2, 0.7% CO2, and 0.3% Propane).

\*\*The molar percent of gas mixes are programmable in 0.1% increments. Any five gases available in Gas-Mix Menu may be used in any proportion totaling 100%..

After installing your TM100 flow meter, power up the device. When the meter finishes initializing, it will begin to monitor flow in the assigned gas and flow units.

### Accessing the Gas-Mix Gas Selection Menu Feature

Enter the programming mode on the meter (refer to p. 48) and then follow these instructions to access the Gas-Mix feature:

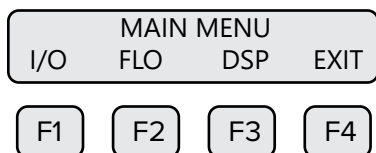

Press **FLO (F2)** from the Main Menu to enter Flow Menu 1.

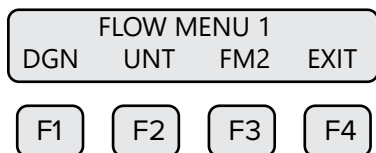

Press **FM2 (F3)** to get to Flow Menu 2.

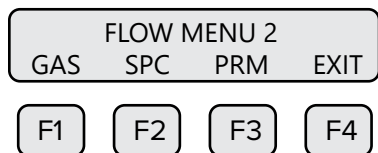

Press **GAS (F1)** to access the Gas-Mix™ feature.

### Choosing a Gas from the Gas-Mix™ Menu

The Gas-Mix™ Menu will show one of the available gases/gas mixtures:

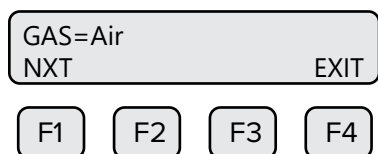

Press **NXT (F1)** to choose from a list of gases. To choose any pure gas, cycle through the gas options until the desired gas is selected, then press **OK (F4)** to choose the gas.

Choices are:

- Methane
- CO2 = Carbon Dioxide
- Nitrogen
- Air
- Natural Gas (mix) \*see definition p. 66
- Argon
- Propane
- Helium
- Oxygen
- Butane
- Hydrogen
- Ethane
- %Mix = Mix of any five gases above; proportions must equal 100%

To create a "Gas Mix," choose **%Mix** from the list and press **OK (F4)**.

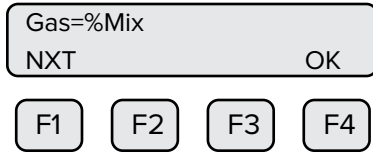

**i NOTE!**

- Gas mix total (sum of percentages) must equal 100%.
- Any gases not included in the gas mix should have percentages set to 0%.

The screen will show:



This screen shows the percentage of the gas mixture allocated to "Methane." In this case, it shows 40%. To program the specific mixture of "Methane," press **CHG (F1)**.

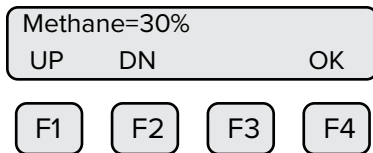

To set the percentage of "Methane" in the gas mix, press **UP (F1)** or **DN (F2)**.

Once the desired "Methane" percentage is displayed, press **OK (F4)**. The display will move to the view of the concentration of each of the subsequent list of gases: Methane, Carbon Dioxide (CO<sub>2</sub>), Nitrogen, Helium, Argon, Hydrogen, Air, Propane, Butane, Oxygen, and Ethane (in that order). Natural Gas is not allowed to be part of the mix, as it is a mix itself.

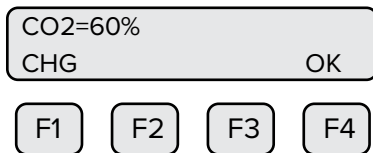

Once the desired gas percentages are programmed, press **OK (F4)**. One of the following messages will appear:

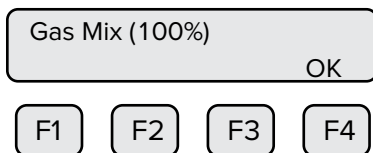

Shows only if no error is detected.  
Pressing OK allows exit to menu.

Err: Mix=(1 10%) OK

F1 F2 F3 F4

Shows only if gas mix does not equal 100%. Pressing OK returns to gas entry.

Err: Max 5 gas OK

F1 F2 F3 F4

Shows only if gas mix does not equal 100%. Pressing OK returns to gas entry.

**i NOTE!** The gas selection must be valid or the gas mix must have a valid 100% mixture before the user is allowed to exit.

Once the "Gas Mix (100%)" message appears, you have successfully programmed the gas mix in Gas-Mix™ and can exit. Press **OK (F4)** to set the mixture.

The TM100 will begin to monitor flow based on the algorithm for the gas selected in the Gas-Mix™ feature. The screen will show the flow in units and the total flow similar to the example below:

1162.52 SCFM  
6205012.50 SCF

F1 F2 F3 F4

From normal operating mode, the gas selection can be seen on Display 3 (see p. 47).

## Communication

### Scope - Modbus Communications

This portion of the manual describes the Modbus implementation using RS485 serial communication physical layer for the Sierra Instruments TM100 Thermal Mass Flow Meter based on the Modicon Modbus Protocol (PI-MBUS-300 Rev. J).

### Modbus Protocol

Modbus Protocol is an application layer messaging protocol that provides client/server communications between devices. Modbus is a request/reply protocol and offers services specified by function codes.

The size of the Modbus Protocol Data Unit is limited by the size constraint inherited from the first Modbus implementation on Serial Line network (max. RS485 Application Data Unit = 256 bytes). Therefore, Modbus PDU for serial line communication = 256 – Server address (1 byte) – CRC (2 bytes) = 253 bytes.

RS485 ADU = 253 + Server address (1 byte) + CRC (2 bytes) = 256 bytes.

For more information on Modbus go to the web site <http://www.modbus.org/>.

Command Request:

<Meter Address> <Function code> <Register start address high> <Register start address low>  
<Register count high> <Register count low> <CRC high> <CRC low>

Command Response:

<Meter Address> <Function code> <Data byte count> <Data register high> <Data register low>  
<Data register high> <Data register low> <CRC high> <CRC low>

 **NOTE!** The data shown in brackets < > represents one byte of data.

### Modbus Indicators

Green LED indicator LP3 cycles on and off to indicate that the TM100 is operating. Orange LED indicator LP2 blinks when Modbus signals are received and Yellow LED P1 blinks when Modbus signals are transmitted. The LEDs are located behind the display panel.

### Modbus Function Codes Supported by the TM100

The TM100 supports the following commands:

- 1) Command 03: Read multiple registers
- 2) Command 04: Read single register.
- 3) Command 06: Write single register
- 4) Command 16: Write multiple registers (limited to gas percentage register pairs)

### Communication Protocol and Parameters

To program the communication parameters, start at the **Main Menu**:

|           |     |     |      |
|-----------|-----|-----|------|
| MAIN MENU |     |     |      |
| I/O       | FLO | DSP | EXIT |
| F1        | F2  | F3  | F4   |

Then press **I/O (F1)** to set Inputs/Outputs:

|         |     |      |    |
|---------|-----|------|----|
| SET I/O |     |      |    |
| COM     | 420 | EXIT |    |
| F1      | F2  | F3   | F4 |

Then press **COM (F1)** to select communication parameters.

Set Bus protocol for Modbus:

|             |    |    |    |
|-------------|----|----|----|
| Comm=Modbus | OK |    |    |
| NXT         |    |    |    |
| F1          | F2 | F3 | F4 |

Press **NXT (F1)** repeatedly until "Modbus" is selected as shown and then press **OK (F4)** to accept the setting.

The following communication settings apply only to Modbus:

|           |    |    |    |
|-----------|----|----|----|
| Baud=9600 | OK |    |    |
| NXT       |    |    |    |
| F1        | F2 | F3 | F4 |

Press **NXT (F1)** repeatedly until the correct selection is shown then press **OK (F4)** to accept the setting.

Selections are:

|        |      |
|--------|------|
| 115200 | 9600 |
| 76800  | 4800 |
| 57600  | 2400 |
| 38400  | 1200 |
| 19200  |      |

|             |    |    |    |
|-------------|----|----|----|
| Parity=EVEN | OK |    |    |
| NXT         |    |    |    |
| F1          | F2 | F3 | F4 |

Press **NXT (F1)** repeatedly until the correct selection is shown and then press **OK (F4)** to accept the setting.

Selections are:

|      |
|------|
| NONE |
| ODD  |
| EVEN |

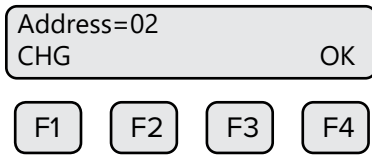

Press **CHG (F1)** to change the address and then press **OK (F4)** to accept the setting. Selections are between 01 and 247

**NOTE!** Power cycle is required for the new settings to take effect.

Table 5.1: TM100 Modbus Registers

| Modbus Register | Description      | Description  | Units                       |
|-----------------|------------------|--|-----------------------------|
| 40001           | 32-bit int LSW   | Flow   | User selected               |
| 40002           | 32-bit int MSW   |  |                             |
| 40003           | 32-bit int LSW   | Flow Total   | User selected               |
| 40004           | 32-bit int MSW   |  |                             |
| 40005           | 32-bit int LSW   | Temperature  | Tenths of user selected     |
| 40006           | 32-bit int MSW   |  |                             |
| 40007           | 32-bit int LSW   | Elapsed time   | Tenths of user selected     |
| 40008           | 32-bit int MSW   |  |                             |
| 40009           | 16-bit int       | Firmware version x10 (scaled up for 16-bit format)                                       |                             |
| 40010           |                  | Reserved   |                             |
| 40011           | 16-bit int       | Flow x 10 (flow scaled for 16 bits)  | Tenths of user selected     |
| 40012           | 16-bit int       | Flow x 100 (flow scaled for 16 bits)   | Hundredths of user selected |
| 40013           | 16-bit int       | Total x 100 (flow total scaled for 16 bits)  | Hundredths of user selected |
| 40014           | 32-bit float LSW | Gross Heating Value (GHV)  | BTU/Ft3                     |
| 40015           | 32-bit float MSW | Gross Heating Value (GHV)  | BTU/Ft3                     |
| 40016           |                  | Status   |                             |
| 40017           |                  | Status 2   |                             |
| 40018           |                  | Control Register (Write Only), Reset Total = 2, Perform TM-Cal = 173, Abort TM-Cal = 174 |                             |
| 40019           | 16-bit int       | Model Status (Read only) TM100 = 0x800   |                             |
| 40020           | 32-bit float LSW | Flow   | User selected               |
| 40021           | 32-bit float MSW |  |                             |
| 40022           | 32-bit float LSW | Total  | User selected               |
| 40023           | 32-bit float MSW |  |                             |
| 40024           | 32-bit float LSW | Reference Pressure (MMHG = 0, PSIA = 1, BARA = 2)  | User selected               |
| 40025           | 32-bit float MSW |  |                             |
| 40026           | 32-bit float LSW | Temperature  | User selected               |
| 40027           | 32-bit float MSW |  |                             |



| Modbus Register | Description      | Description   | Units           |
|-----------------|------------------|---|-----------------|
| 40028           | 32-bit float LSW | Elapsed time  | Hours           |
| 40029           | 32-bit float MSW |   |                 |
| 40030           | 32-bit float LSW | Calibration validation result   |                 |
| 40031           | 32-bit float MSW |   |                 |
| 40032-40037     |                  | Reserved  |                 |
| 40038           | 16-bit int       | <b>Flow Unit Code:</b> SCFM = 0, SCFH = 1, NM3_H = 2, NM3_M = 3, KG_H = 4, KG_M = 5, KG_S = 6, LBS_H = 7, LBS_M = 8, LBS_S = 9, NLPH = 10, NLPM = 11, MMSCFD = 15, LBS_D = 16, SLPM = 17, NLPS = 18, MSCFD = 19, SM3_H = 20, MT_H = 21, NM3_D = 22, MMSCFM = 23, SCFD = 24, MCFD = 25, SM3M = 26, SM3D = 27 | User selected   |
| 40039           | 16-bit int       | Temp Unit Code (Degree F = 0, Degree C = 1)   | User selected   |
| 40040           | 16-bit int       | Pressure Unit Code (MMHG = 0, PSIA = 1, BARA = 2)   | User selected   |
| 40041 to 40196  |                  | Reserved  |                 |
| 40197           | 32-bit float LSW | Gas Density   | STP KG/M3       |
| 40198           | 32-bit float MSW |   |                 |
| 40199           | 32-bit float LSW | Meter Serial Number   |                 |
| 40200           | 32-bit float MSW |   |                 |
| 40201           | 16-bit int       | ADC Status  |                 |
| 40202           | 32-bit float LSW | Electronics Temperature   | Degrees Celsius |
| 40203           | 32-bit float MSW |   |                 |
| 40204           | 16-bit int       | Last TM-Cal Year**  | Years           |
| 40205           | 16-bit int       | Last TM-Cal Month**   | Month           |
| 40206           | 16-bit int       | Last TM-Cal Day**   | Days            |
| 40207           | 16-bit int       | Last TM-Cal Hour**  | Hours           |
| 40208           | 16-bit int       | Last TM-Cal Min**   | Minutes         |
| 40209           | 16-bit int       | Last TM-Cal Sec**   | Seconds         |
| 40210           | 32-bit float LSW | Last TM-Cal Value   |                 |
| 40211           | 32-bit float MSW | Last TM-Cal Value   |                 |

\*\*Last TM-Cal Data and Time is only valid when using TM100 View Software.

## NOTES!

-  In the table, LSW means Least Significant Word, and MSW means Most Significant Word. In this case a “word” is one 16-bit Modbus register. A 32-bit float or 32-bit integer is stored in a pair of Modbus registers. When a register is designated as “32-bit int LSW”, it means that bits 0-15 of the variable are in that register. A register designated as MSW has bits 16-31 of the variable. For instance, the flow total can be read as a 32-bit integer from registers 40003 (LSW) and 40004 (MSW). If the flow total is 0x12345678, then register 40003 will hold 0x5678, and register 40004 will hold 0x1234. See the layout of a 32-bit floating point value on page 74.
- 32-bit floating point values are defined by the IEEE 754 standard: <https://ieeexplore.ieee.org/document/8766229>
- Refer also to Wikipedia: [https://en.wikipedia.org/wiki/Single-precision\\_floating-point\\_format](https://en.wikipedia.org/wiki/Single-precision_floating-point_format)

**Read Multiple Registers (command 03)**

This command reads one or more 16 bit registers from the TM100 and has the following format:

Request:

<Meter Address> <Command code=03> <Register start address high> <Register start address low>  
<Register count high> <Register count low> <CRC high> <CRC low>

Response:

<Meter Address> <Command code=03> <Byte count> <Data high><Data low> ... <Data high>  
<Data low> <CRC high> <CRC low>

Example: Request data register at starting address 0x0000 and specifying 2 registers

<0x01> <0x03> <0x00> <0x00> <0x00> <0x02> <0xC4> <0x0B>

Response:

<0x01> <0x03> <0x04> <xx> <xx> <xx> <xx> <CRC high> <CRC low>

Where xx xx is the data register value.

**Read Single Register (Command 04)**

This command is used to report the status information.

Request:

<Meter Address> <Command code=04> <Register address =0> <Register address =0>  
<Register count =0> <Register count =1> <CRC high> <CRC low>

Response:

<Meter Address> <Command code=04> <Byte count =2> <Status High> <Status Low>  
<CRC high> <CRC low>

Table 5.2: Status Bits Definitions for Command 04, Modbus Address 40016

| Bit | Definition                               | Comment                                   |
|-----|--|---|
| 0   | Power up indication                      | Cleared when out of the power up sequence |
| 1   | Flow rate reached high limit threshold   | Set limit to zero to disable              |
| 2   | Flow rate reached low limit threshold    | Set limit to zero to disable              |
| 3   | Temperature reached high limit threshold | Set limit to zero to disable              |
| 4   | Temperature reached low limit threshold  | Set limit to zero to disable              |
| 5   | Sensor reading is out of range           | Check sensor wiring                       |
| 6   | Gas mix error                            | Gas mix must total 100%                   |
| 7   | Incorrect Settings                       | Check settings                            |
| 8   | In simulation mode                       | Set simulation value to 0 to disable      |
| 9   | Pulse/alarm output is out of range       | Check pulse/alarm output settings         |
| 10  | Analog CH1 4-20mA is out of range        | Check analog output settings              |
| 11  | Analog CH2 4-20mA is out of range        | Check analog output settings              |
| 12  | Not used                                 | Not used                                  |
| 13  | Not used                                 | Not used                                  |
| 14  | CRC error                                | Check parameters and reset CRC            |
| 15  | Error in Total                           | Reset total to clear alarm                |

Table 5.3: Status 2 Bits Definitions for Command 04, Modbus Address 40017

| Bit | Definition        | Comment |
|-----|-------------------|---------|
| 0   | Pulse hardware    |         |
| 1   | Busy              |         |
| 2   | HART hardware     |         |
| 3   | Not used          |         |
| 4   | TM-Cal in process |         |
| 5   | TM-Cal fail       |         |
| 6   | TM-Cal aborted    |         |
| 7   | TM-Cal warning    |         |

### Write Single Register (Command 06)

This command is used to perform miscellaneous functions such as clearing the totalizer and elapsed time. The register address is Modbus=40018 and the data to write is described in table 5.1.

Request

<Meter Address> <Command code=06> <Register address =0x00> <Register address =0x11>  
<Register data=0x00> <Register data =0x02> <CRC high> <CRC low>

Response:

<Meter Address> <Command code=06> <Register address =0x00> <Register address =0x11>  
<Register data=0x00> <Register data =0x02> <CRC high> <CRC low>

### Write Multiple Registers (Command 16)

This command is restricted to writing to the gas mix percentage settings in registers 40058 - 40061. Reference Table 5.5, pg 79. The preset single register command is not allowed to write to these registers. The percentage settings are 32-bit floating point numbers in units of percent. A setting of 12.7 means 12.7%.

Request:

<Meter Address> <Command code=16 (0x10)> <Starting register address MSB> <Starting register address LSB> <Number of registers MSB> <Number of registers LSB> <Byte count> <Register data MSB> <Register data LSB> ... <Register data MSB> <Register data LSB> <CRC LSB> <CRC MSB>

Response:

<Meter Address> <Command code=16 (0x10)> <Starting register address MSB> <Starting register address LSB> <Number of registers high> <Number of registers low> <CRC LSB> <CRC MSB>

**NOTE!** Response message issue with firmware older than v5.5: the starting register in the response message is incorrect.

### Floating Point Data Layout

Each 32-bit floating point value uses two consecutive Modbus registers. The most significant byte of the lower numbered register holds the least significant byte of the significand. The least significant byte of the lower numbered register holds the next most significant byte of the significand. The most significant byte of the higher numbered register holds the sign bit and most significant 7 bits of the exponent. The least significant byte of the higher numbered register holds the least significant bit of the exponent and the most significant 7 bits of the significand.

#### In the following tables:

S0 – S23 are the significand bits from least to most significant.

E0 – E7 are the exponent bits from least to most significant.

Sign is 1 if the number is negative, and 0 if the number is positive.

| Lower numbered register |     |     |     |     |     |    |    |    |    |    |    |    |    |    |    |
|-------------------------|-----|-----|-----|-----|-----|----|----|----|----|----|----|----|----|----|----|
| 15                      | 14  | 13  | 12  | 11  | 10  | 9  | 8  | 7  | 6  | 5  | 4  | 3  | 2  | 1  | 0  |
| S15                     | S14 | S13 | S12 | S11 | S10 | S9 | S8 | S7 | S6 | S5 | S4 | S3 | S2 | S1 | S0 |

| Higher numbered register |    |    |    |    |    |    |    |    |     |     |     |     |     |     |     |
|--------------------------|----|----|----|----|----|----|----|----|-----|-----|-----|-----|-----|-----|-----|
| 15                       | 14 | 13 | 12 | 11 | 10 | 9  | 8  | 7  | 6   | 5   | 4   | 3   | 2   | 1   | 0   |
| Sign                     | E7 | E6 | E5 | E4 | E3 | E2 | E1 | E0 | S22 | S21 | S20 | S19 | S18 | S17 | S16 |

Since the Modbus register data is sent most significant byte first and the registers are sent lowest numbered first, a floating point value will look like this in the data stream:

| First byte (MSB of lower register) |     |     |     |     |     |     |    |    |
|------------------------------------|-----|-----|-----|-----|-----|-----|----|----|
| Data bit                           | 7   | 6   | 5   | 4   | 3   | 2   | 1  | 0  |
| Value bit                          | S15 | S14 | S13 | S12 | S11 | S10 | S9 | S8 |

| Second byte (LSB of lower register) |    |    |    |    |    |    |    |    |
|-------------------------------------|----|----|----|----|----|----|----|----|
| Data bit                            | 7  | 6  | 5  | 4  | 3  | 2  | 1  | 0  |
| Value bit                           | S7 | S6 | S5 | S4 | S3 | S2 | S1 | S0 |

| Third byte (MSB of higher register) |      |    |    |    |    |    |    |    |
|-------------------------------------|------|----|----|----|----|----|----|----|
| Data bit                            | 7    | 6  | 5  | 4  | 3  | 2  | 1  | 0  |
| Value bit                           | Sign | E7 | E6 | E5 | E4 | E3 | E2 | E1 |

| Fourth byte (LSB of higher register) |    |     |     |     |     |     |     |     |
|--------------------------------------|----|-----|-----|-----|-----|-----|-----|-----|
| Data bit                             | 7  | 6   | 5   | 4   | 3   | 2   | 1   | 0   |
| Value bit                            | E0 | S22 | S21 | S20 | S19 | S18 | S17 | S16 |

Example: For Methane, register pair 40058-40059 must be set to 60.  
 To set Carbon Dioxide to 40, use registers 40060-40061.

First you must set the Gas-Mix code to 250 for Gas Mix, using a preset single register command to 40057. Then you will be able to set the gas percentages.

The message byte stream will be (bytes on the same line are sent leftmost first):

```

<0x01>           Address = 1
<0x10>           Function = write multiple registers
<0x00> <0x39>    Start index = fifty seven, meaning register 40058
<0x00> <0x22>    Register count = 34 (holding seventeen 32-bit floating point values)
<0x44>           Number of data bytes = 68
<0x00> <0x00> <0x42> <0x70> Value = 60.0%
<0x00> <0x00> <0x00> <0x00> value = 0.0%
<0x00> <0x00> <0x00> <0x00> value = 0.0%
<0x00> <0x00> <0x00> <0x00> value = 0.0%
<0x00> <0x00> <0x00> <0x00> value = 0.0%
<0x00> <0x00> <0x00> <0x00> value = 0.0%
<0x00> <0x00> <0x00> <0x00> value = 0.0%
<0x00> <0x00> <0x00> <0x00> value = 0.0%
<0x00> <0x00> <0x00> <0x00> value = 0.0%
<0x00> <0x00> <0x00> <0x00> value = 0.0%
<0x00> <0x00> <0x00> <0x00> value = 0.0%
<0x00> <0x00> <0x00> <0x00> value = 0.0%
<0x00> <0x00> <0x00> <0x00> value = 0.0%
<0x00> <0x00> <0x00> <0x00> value = 0.0%
<0x00> <0x00> <0x00> <0x00> value = 0.0%
<0x00> <0x00> <0x00> <0x00> value = 0.0%
<0x00> <0x00> <0x00> <0x00> value = 0.0%
    
```

<0x00> <0x00> <0x42> <0x20> value = 40.0%  
 <0xCA> <0x24> CRC

Response message:

<0x01> Address = 1  
 <0x10> Function = write multiple registers  
 <0x00> <0x39> Start index = fifty-seven = register 40058  
 <0x00> <0x44> Number of data bytes written = 68  
 <0x10> <0x37> CRC

### Using Modbus to Program Gas-Mix™

Modbus can be used to access and program gases/gas mixes in the Gas-Mix™ feature available on the TM100.

### Selecting TM100 Gases and Gas Mixes

Modbus register 40056 selects the gas type, which may be a pure gas (plus NAESEB natural gas composition) or custom gas mix. Register 40057 will read zero, and register 40056 will read the gas selection that was chosen. Writing to register 40057 will produce an error response. See the Gas-Mix Codes (Table 5.4) for the values to write.

Table 5.4: Gas Selection Codes

| Selection Code | Gas                              |
|----------------|----------------------------------|
| 0              | Methane                          |
| 1              | CO2 (Carbon Dioxide)             |
| 2              | Nitrogen                         |
| 3              | Air                              |
| 4              | Natural Gas                      |
| 5              | Argon                            |
| 6              | Propane                          |
| 7              | Helium                           |
| 8              | Oxygen                           |
| 10             | Butane                           |
| 11             | Hydrogen                         |
| 13             | Ethane                           |
| 250            | Mixed gas (must set percentages) |

### Setting Mix Percentages

To set a custom gas mix, first set the Selection Code to 250 (Mixed Gas). Next, go through each gas mix register and set the percentages to the desired 32-bit floating point values (see table 5.5 below, where these values are split in two 16-bit registers). Ensure that you don't exceed the maximum number of gas components allowed for this model (5) and that all gas percentages entered add up to exactly 100.0%. Do not write a custom gas percentage when the Selection Code is set to a pure gas (see codes 0 through 11 in Table 5.4 above). Again, the Selection Code must be set to 250 (Mixed Gas) for the custom gas percentage registers to function properly.

Table 5.5: TM100 Modbus Holding Registers for Gas-Mix™

|               |                  |                           |   |
|---------------|------------------|---------------------------|---|
| 40056         | 16-bit int       | Gas type selection        | See table of gas selection codes for Modbus |
| 40057         | 16-bit int       | Gas type selection        |   |
| 40058         | 32-bit float LSW | Methane (C1) percentage   | Percent (31.4 = 31.4%)                      |
| 40059         | 32-bit float MSW |                           |   |
| 40060         | 32-bit float LSW | Carbon Dioxide percentage | Percent (31.4 = 31.4%)                      |
| 40061         | 32-bit float MSW |                           |   |
| 40062         | 32-bit float LSW | Nitrogen percentage       | Percent (31.4 = 31.4%)                      |
| 40063         | 32-bit float MSW |                           |   |
| 40064         | 32-bit float LSW | Air percentage            | Percent (31.4 = 31.4%)                      |
| 40065         | 32-bit float MSW |                           |   |
| 40066         | 32-bit float LSW | Argon percentage          | Percent (31.4 = 31.4%)                      |
| 40067         | 32-bit float MSW |                           |   |
| 40068         | 32-bit float LSW | Propane percentage        | Percent (31.4 = 31.4%)                      |
| 40069         | 32-bit float MSW |                           |   |
| 40070         | 32-bit float LSW | Helium percentage         | Percent (31.4 = 31.4%)                      |
| 40071         | 32-bit float MSW |                           |   |
| 40072         | 32-bit float LSW | Oxygen percentage         | Percent (31.4 = 31.4%)                      |
| 40073         | 32-bit float MSW |                           |   |
| 40074         | 32-bit float LSW | Butane percentage         | Percent (31.4 = 31.4%)                      |
| 40075         | 32-bit float MSW |                           |   |
| 40076         | 32-bit float LSW | Hydrogen percentage       | Percent (31.4 = 31.4%)                      |
| 40077         | 32-bit float MSW |                           |   |
| 40080         | 32-bit float LSW | Ethane percentage         | Percent (31.4 = 31.4%)                      |
| 40081         | 2-bit float MSW  |                           |   |
| 40082 - 40196 |                  | Reserved                  |   |

### NOTES!

- In the table, LSW means Least Significant Word, and MSW means Most Significant Word. In this case a “word” is one 16-bit Modbus register. A 32-bit float or 32-bit integer is stored in a pair of Modbus registers. When a register is designated as “32-bit int LSW”, it means that bits 0-15 of the variable are in that register. A register designated as MSW has bits 16-31 of the variable. For instance, the flow total can be read as a 32-bit integer from registers 40003 (LSW) and 40004 (MSW). If the flow total is 0x12345678, then register 40003 will hold 0x5678, and register 40004 will hold 0x1234. See the layout of a 32-bit floating point value on page 78.
- 32-bit floating point values are defined by the IEEE 754 standard: <https://ieeexplore.ieee.org/document/8766229>
- Refer also to Wikipedia: [https://en.wikipedia.org/wiki/Single-precision\\_floating-point\\_format](https://en.wikipedia.org/wiki/Single-precision_floating-point_format)

## Scope - BACnet Communications

This portion of the manual describes the BACnet MS/TP (RS485) implementation using RS485 serial communication physical layer for the Sierra Instruments TM100 Mass flow meter.

### BACnet Protocol

BACnet MS/TP (Building Automation and Control Network/Master Slave Token Passing) is a data link layer protocol designed for communication between devices in building automation control systems. The protocol is based on devices, objects, properties, and services. Information inside a BACnet device is organized into a series of objects. Properties allow the data from the object to be written or read. The actions that a BACnet device uses to interact with another device are the services.

The TM100 Device profile: BACnet Smart Sensor (B-SS)

TM100 supports the following device binding methods:

Receive Who-Is, send I-Am (BIBB DM-DDB-B)  
Receive Who-Has, send I-Have (BIBB DM-DOB-B)

Objects for TM100:

Analog Input 1 = Flow  
Analog Input 2 = Gas Temperature  
Analog Input 3 = Total Flow / Reset Total  
Analog Input 4 = Elapsed Time since reset

### BACnet Indicators

LED indicator LP3 cycles on and off to indicate that the TM100 is operating.

LED indicator LP2 blinks when BACnet signals are received and LP1 blinks when BACnet signals are transmitted.

Device object property identifiers and restrictions: (properties that are writable)

|                     |                  |
|---------------------|------------------|
| Object _Name        | < 10 bytes       |
| Object _ Identifier | Device Type only |
| Max _ info_ Frames  | <=255            |
| Max _ Master        | <=127            |

BACnet Interoperability Building Blocks (BIBB'S) provide function capabilities for data exchange between devices.

TM100 BIBB's supported:

DS-RP-B Read Property  
DS-WP-B Write Property  
DM-DDB-B Dynamic Device Binding  
DM-DOB-B Dynamic Object Binding  
DM-DCC-B Device Communication Control  
DS-RPM-B ReadPropertyMultiple  
DM-RD-B Reinitialize Device



MS/TP baud rates:

9600, 19200, 38400, 57600, 76800, 115200

TM100 Character sets supported:

ANSI X3.4, UTF-8

Sierra Instruments BACnet vendor ID: 650

For more information about BACnet visit <http://www.bacnet.org/>.

### Communication Protocol and Parameters

To program the communication parameters, press **I/O (F1)** key from the Main Menu.

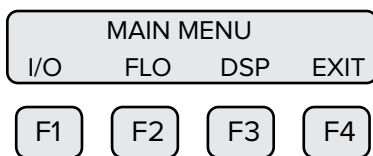

This is the Main Menu for the programming mode. To exit the programming mode, press EXIT (F4) repeatedly until “Normal Mode” is seen briefly. Choose I/O (F1) to access the communication output.

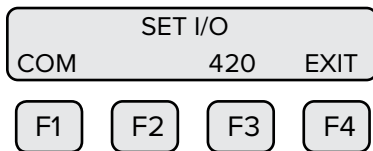

Then press **COM (F1)** to select communication parameters.

Set Bus protocol for BACnet:

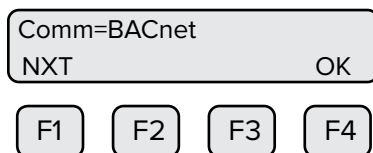

Press **NXT (F1)** until BACnet is selected as shown and then press **OK (F4)** to accept the setting.

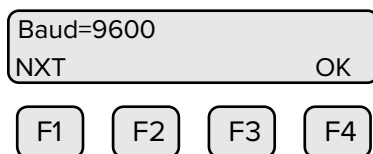

Press **NXT (F1)** repeatedly until the correct selection is shown and then press **OK (F4)** to accept the setting. Selections are: “9600”

“19200”

“38400”

“57600”

“76800”

“115200”

Next select the MS/TP Mac address. The selection is from 0-127. Please note that only one device can be on a MS/TP Mac address.

|   |
|---|
| MAC_ADD=23                                |
| CHG <span style="float: right;">OK</span> |

F1 F2 F3 F4

Next select the MS/TP Max Master using **CHG (F1)**. The selection is from 0-127. Press **OK (F4)** to accept the setting.

|   |
|---|
| MAX_MASTER=127                            |
| CHG <span style="float: right;">OK</span> |

F1 F2 F3 F4

Next input the device object instance using **CHG (F1)**. Selection is from 0-4194303. Press **OK (F4)** to accept the setting.

|   |
|---|
| ID=12531                                  |
| CHG <span style="float: right;">OK</span> |

F1 F2 F3 F4

Next enter the device object name (9 characters maximum) using **CHG (F1)**. Press **OK (F4)** to accept the setting.

|   |
|---|
| NAME=TM100                                |
| CHG <span style="float: right;">OK</span> |

F1 F2 F3 F4

 **NOTE!** Power cycle is required for the new settings to take effect.

### Scope - HART Communications

The Sierra Instruments TM100 transmitter complies with HART Protocol Revision 7.1. This section of the manual specifies all the device-specific features and documents HART Protocol implementation details (e.g., the Engineering Unit Codes supported). The functionality of this Field Device is described sufficiently to allow its proper application in a process and its complete support in HART-capable Host Applications.

### Purpose

This specification provides a complete description of this Field Device from a HART Communication perspective. The specification is designed to be a technical reference for HART capable Host Application Developers, System Integrators and knowledgeable End Users. It also provides functional specifications (e.g., commands and performance requirements) used during development, maintenance and testing. This document assumes the reader is familiar with HART Protocol requirements and terminology.

### References

HART Smart Communications Protocol Specification. HCF\_SPEC-12.

### Device Identification

|                                   |                                     |                          |                  |
|-----------------------------------|-------------------------------------|--------------------------|------------------|
| <b>Manufacturer Name:</b>         | Sierra Instruments Instruments      | <b>Model Name:</b>       | TM100            |
| <b>Manufacture ID Code:</b>       | 165                                 | <b>Device Type Code:</b> | 57583 (EOEF Hex) |
| <b>HART Protocol Revision:</b>    | 7.1                                 | <b>Device Revision:</b>  | 1                |
| <b>No. of Device Variables:</b>   | None                                |                          |                  |
| <b>Physical Layers Supported:</b> | FSK                                 |                          |                  |
| <b>Physical Device Category:</b>  | Transmitter, DC-isolated Bus Device |                          |                  |

### Product Overview

The TM100 HART communication option can be monitored and configured using a HART master device or a hand-held communicator.

### Process Flow Rate 4-20mA Analog Output

The 4-20mA output of the TM100 HART represents the process flow rate measurement, linearized and scaled according to the configured range of the instrument. This output corresponds to the Primary Variable. HART Communication is supported on this loop.

The 4-20mA output of the TM100 should be configured for flow rate when using HART. If the 4-20mA output is set to report temperature, HART communication will report the 4-20mA value for temperature rather than flow.

### HART Indicators

Green LED indicator LP3 cycles on and off to indicate that the TM100 is operating. Orange LED indicator LP2 blinks when HART signals are received and Yellow LP1 blinks when HART signals are transmitted. The LEDs are located behind the display panel.

The orange LED indicator LP2 will be on continuously when HART communication is enabled and the 4-20mA wiring is not connected.

### TM100 HART Communication Setup

HART communication must be selected in the TM100 Serial Communication menu for HART communication to operate. When this communication parameter is changed, power to the TM100 must be cycled for it to take effect.

### Communication Protocol and Parameters

To program the communication parameters, press **I/O (F1)** key from the **Main Menu**.

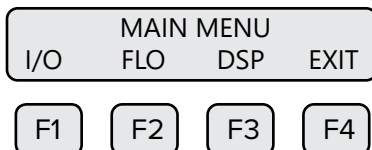

This is the Main Menu for the programming mode. To exit the programming mode, press **EXIT (F4)** repeatedly until “Normal Mode” is seen briefly. Choose **I/O (F1)** to access the communication output.

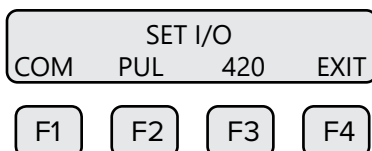

Then press **COM (F1)** to select communication parameters.

Set Bus protocol for HART:

Comm=HART OK

F1
F2
F3
F4

Press **NXT (F1)** until HART is selected as shown and then press **OK (F4)** to accept the setting.

**NOTE!** Power cycle is required for the new settings to take effect.

### Dynamic Variables

Four Dynamic Variables are implemented.

| Variable | Meaning      | Units             |
|----------|--------------|-------------------|
| PV       | Flow Rate    | In Selected Units |
| SV       | Total        | In Selected Units |
| TV       | Temperature  | In Selected Units |
| QV       | Elapsed Time | In Hours          |

### Status Information

#### Device Status

Bit 4 ("More Status Available") is set when any failure is detected. Command #48 provides additional detail.

#### Extended Device Status

This bit is set if a sensor error is detected. "Device Variable Alert" is set if the Primary Variable (PV) is out of limit.

**Additional Device Status (Command 48)**

Command #48 returns 2 Device-Specific Status bytes of data, with the following status information: These bits are set when an alarm or error condition is present. The bit automatically clears when the condition returns to its normal state.

| Byte | Bit | Meaning                      | Class  |
|------|-----|------------------------------|--------|
| 0    | 0   | Power Up Indication          | Status |
|      | 1   | High Flow Limit Alarm        | Alarm  |
|      | 2   | Low Flow Limit Alarm         | Alarm  |
|      | 3   | High Temperature Limit Alarm | Alarm  |
|      | 4   | Low Temperature Limit Alarm  | Alarm  |
|      | 5   | Sensor out of range          | Error  |
|      | 6   | Velocity out of range        | Error  |
|      | 7   | Check Parameter Settings     | Error  |

|   |   |                               |       |
|---|---|-------------------------------|-------|
| 1 | 0 | In Simulation Mode            | Alarm |
|   | 1 | Frequency output out of range | Alarm |
|   | 2 | CH 1 4-20mA out of range      | Alarm |
|   | 3 | CH 2 4-20mA out of range      | Alarm |
|   | 4 | Busy                          | Alarm |
|   | 5 | Bridge shutdown               | Error |
|   | 6 | CRC database error            | Error |
|   | 7 | Error with Total              | Error |

**Common-Practice Commands, Supported Commands**

The following common-practice commands are implemented:

- 34 Write Primary Variable (PV) Damping Value
- 35 Write PV Range Value
- 36 Set PV Upper Range Value
- 37 Set PV Lower Range Value
- 38 Reset "Configuration Changed" Flag
- 40 Enter/Exit Fixed Current Mode
- 44 Write PV Units
- 45 Trim Loop Minimum
- 46 Trim Loop Maximum
- 48 Read Additional Device Status (Command #48 returns 2 bytes of data)
- 59 Write Number of Response Preambles

**Common-Practice Commands, Unsupported Commands**

**Burst Mode** - This device does not support Burst Mode.

**Catch Device Variable** - This device does not support Catch Device Variable.

**Device-Specific Commands** - No Device-Specific commands are implemented.

**Modes**

Fixed current mode is implemented, using Command 40. This mode is cleared by power loss or reset.

**Damping**

Damping is standard, affecting only the PV and the loop current signal.

**Capability Checklist**

|   |                           |
|---|---------------------------|
| <b>Manufacturer, model</b>                  | Sierra Instruments, TM100 |
| <b>Device Type</b>                          | Transmitter               |
| <b>HART revision</b>                        | 7.1                       |
| <b>Device Description available</b>         | No                        |
| <b>Number and type of sensors</b>           | 1                         |
| <b>Number and type of actuators</b>         | 0                         |
| <b>Number and type of host side signals</b> | 1 : 4-20mA analog         |
| <b>Number of Device Variables</b>           | 0                         |
| <b>Number of Dynamic Variables</b>          | 4                         |
| <b>Mappable Dynamic Variables</b>           | No                        |
| <b>Number of common-practice commands</b>   | 17                        |
| <b>Number of device-specific commands</b>   | 0                         |
| <b>Bits of additional device status</b>     | 8                         |
| <b>Alternative operating modes</b>          | No                        |
| <b>Burst mode</b>                           | No                        |
| <b>Write-protection</b>                     | Yes                       |

## Maintenance

### PRECAUTIONS

 **WARNING!** BEFORE ATTEMPTING ANY MAINTENANCE, TAKE THE NECESSARY SAFETY PRECAUTIONS BEFORE REMOVING THE PROBE FROM THE DUCT (EXAMPLE: PURGE LINES OF TOXIC AND/OR EXPLOSIVE GAS, DEPRESSURIZE, ETC...).

**WARNING!** EXPLOSION HAZARD. DO NOT REMOVE OR REPLACE COMPONENTS OR FUSES UNLESS POWER HAS BEEN SWITCHED OFF WHEN A FLAMMABLE OR COMBUSTIBLE ATMOSPHERE IS PRESENT.

**WARNING!** EXPLOSION HAZARD. DO NOT DISCONNECT EQUIPMENT WHEN A FLAMMABLE OR COMBUSTIBLE ATMOSPHERE IS PRESENT.

### ACCESS TO ELECTRONICS

Accessing electronics is not normally required for maintenance purposes. If a loose connection is suspected, unscrew the cap of the meter to access the wiring terminations.

 **CAUTION!** BE SURE POWER TO METER IS SWITCHED OFF BEFORE ATTEMPTING TO ACCESS ELECTRONICS. If there is a problem and a loose connection is not found, please contact Sierra Instruments Customer Service for technical assistance at (831) 373-0200.

### Broken or Damaged Probe

If the sensor is broken or damaged, the probe and electronics must be returned to the factory. A new sensor will be installed and calibrated. Refer to "Returning Your Meter" on p. 104.

### Flow Calibration and Calibration Validation

To ensure high accuracy of your TM100 Thermal Mass Flow Meter, Sierra Instruments provides a full NIST traceable calibration. It is recommended that the meter's accuracy be checked annually by performing the TM-Cal™ Calibration Validation test.



## FUSE REPLACEMENT

 **WARNING!** TURN INPUT POWER OFF BEFORE REMOVING OR INSTALLING A FUSE. USE ONLY RECOMMENDED FUSE REPLACEMENTS.

Verify the fuse is defective by measuring it with an Ohm Meter (Two replacement fuses are provided with each unit). Replacement fuse is Littelfuse part number 0454.750MR

### To replace the fuse:

The fuse F1 is located near the power terminal block and can be removed by using tweezers or needle-nose pliers.

### Sensor Cleaning

The sensor is insensitive to small amounts of residue, but continued use in dirty environments will require periodic cleaning. To inspect the sensor, remove power from electronics and remove the unit from the pipe or duct, exposing the sensor elements. If they are visibly dirty, clean them with water or alcohol (ethanol) using an appropriate brush until they appear clean again. Even though the sensor elements are rugged, avoid touching them with any solid object and use a light touch while cleaning them.

## Instructions for Removing and Inserting the Meter from a Pressurized Pipe using the Retractor

- ❗ **WARNING!** Possible injury or damage to equipment may occur if the retractor is not used correctly. Please read the following instructions carefully prior to using the retractor.
- ❗ **CAUTION!** Never remove the restraint cable without first closing the Ball Valve and bleeding off pressure.
- ❗ **WARNING!** When working with the retractor, do not stand or position any part of your body in the path of the flow meter. An injury may occur if the probe is forced outward by system pressure.

### How to Remove the Meter from the Retractor (System Pressurized)

#### Step 1 - Remove the Probe from the Flow Stream

1. Disconnect power from the meter.

❗ **NOTE!** At 150 psig of max system pressure, the probe will have approximately 66 lbs. of force pushing it out.

2. System pressure may force the probe out of the retractor when the compression nut is loosened. Hold the flow meter to counteract the force of the system pressure, and carefully loosen and unscrew the compression nut.
3. While supporting the meter, slowly slide the probe out of the retractor until the restraint cable is taut.
4. Close the ball valve all the way.

❗ **CAUTION!** At this point there is still pressure inside of the retractor.

Figure 6.1

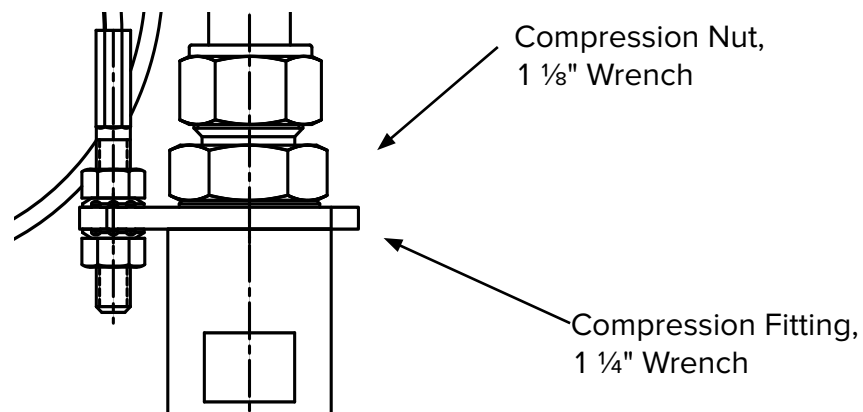

**Step 2 - Remove the Probe from the Retractor Body**

5. After removing the probe from the flow stream (#1-4 on previous page), slowly loosen the compression fitting (see figure 6.1), until the pressure in the retractor is relieved.
6. Retighten the compression fitting.
7. Remove the Collar Clamp by using a 3/16" Hex Key.
8. Carefully slide the probe out of the retractor while supporting the meter.

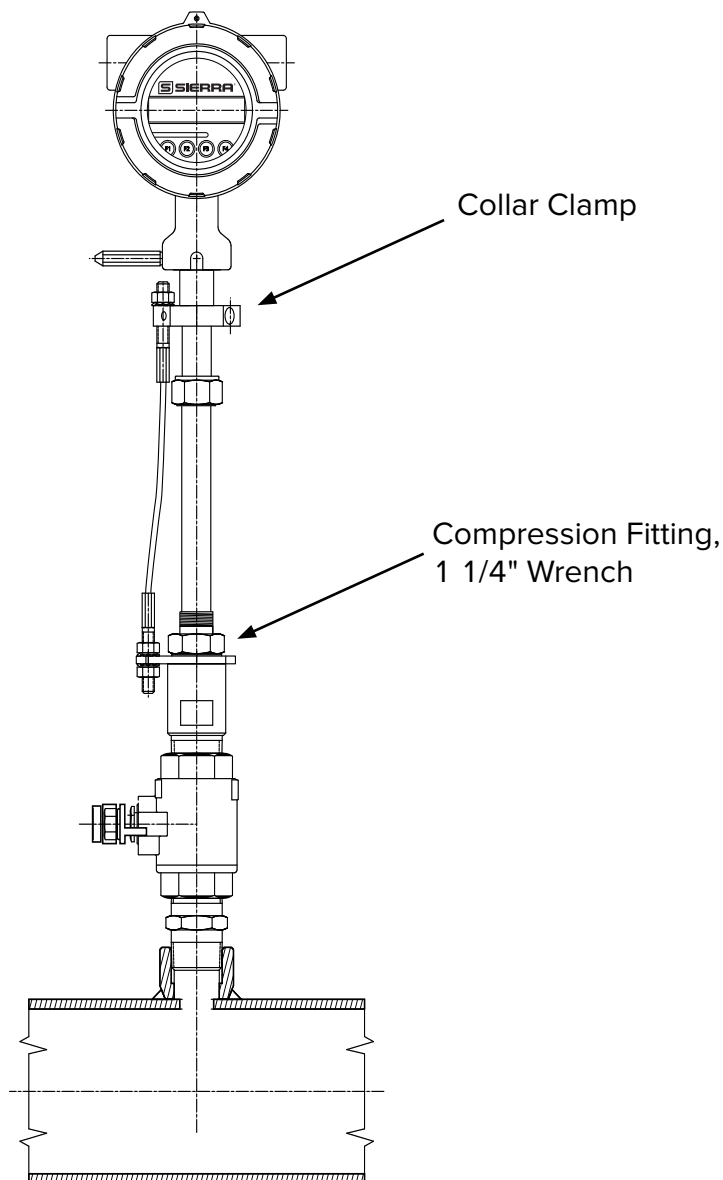
*Figure 6.2*

**How to Insert the Probe into the Flow Stream (Valve closed, System Pressurized)**

1. Carefully, slide the probe into the retractor.
2. Install the collar clamp just below the collar spacer, and tighten it in place on the probe. Slide the probe back out of the retractor until the cable is straight and taut.

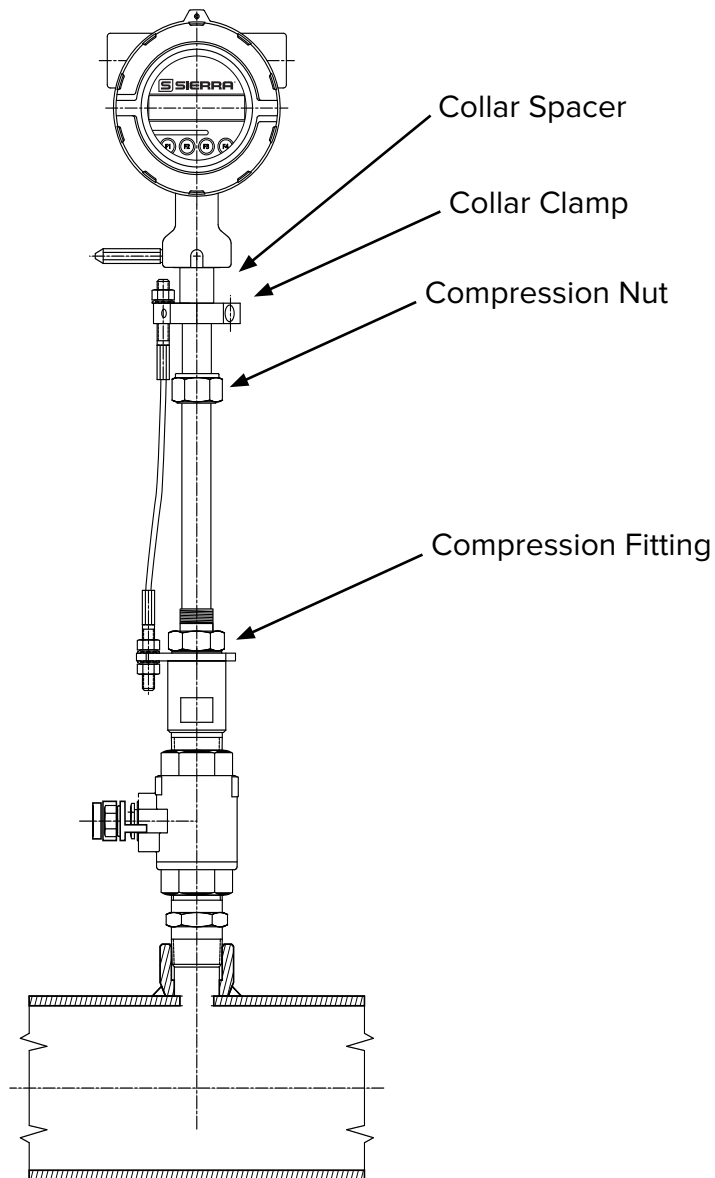
*Figure 6.3*

3. Slowly open the ball valve to the full open position. Push the meter and probe into the pipe, then hand tighten the compression nut onto the compression fitting.

**i NOTE!** At a maximum system pressure of 150 psig, the force required to push the probe in place to tighten the compression nut will be approximately 66 lbs.

4. Verify that the probe is aligned with the center line of the pipe, and pointed in the direction of flow.

Figure 6.4

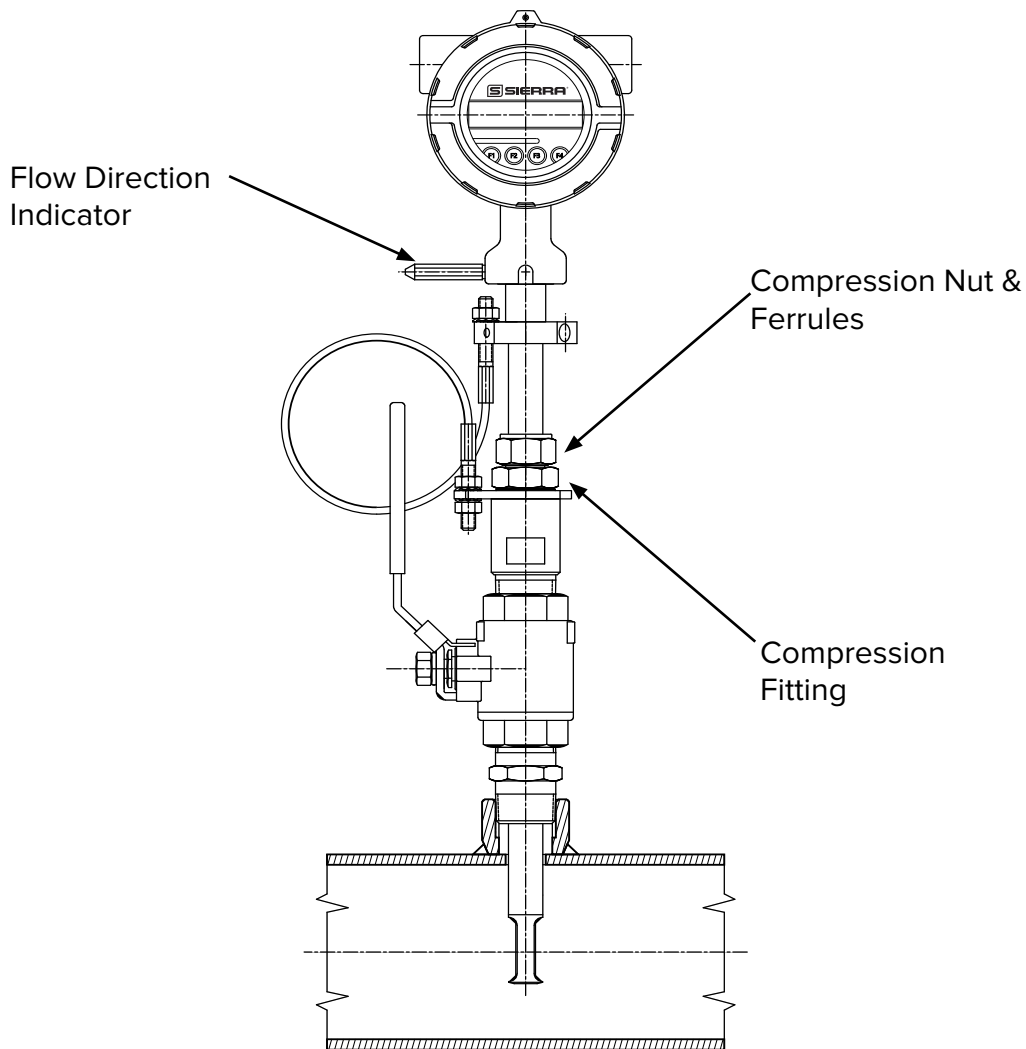

5. Secure the probe in place by tightening the compression nut with a  $1 \frac{1}{8}$ " wrench and a  $1 \frac{1}{4}$ " wrench on the compression fitting. See p. 27 of the manual for detailed instructions to tighten the compression nut.

6. Power may now be applied to the meter.

## Troubleshooting

**CAUTION!** The electronics and sensor supplied by Sierra Instruments are calibrated as a single precision mass flow meter. Interchanging sensors will decrease the accuracy of the flow meter. If you experience any problem with your TM100, call Sierra Instruments Customer Service Department, Technical Assistance at (831) 373-0200.

| Problem                                    | Possible Cause   | Action   |
|--|--|--|
| Meter does not initialize                  | <ol style="list-style-type: none"> <li>1. Malfunction in flow meter</li> <li>2. Electromechanical interference</li> </ol>  | <ol style="list-style-type: none"> <li>1. Return flow meter to Sierra Instruments for repair (Refer to p. 104 for shipping instructions)</li> <li>2. Check meter power cycles.</li> <li>3. Press and release F1 and F2 at the same time; the display will enter Engineering screens.</li> <li>4. Press F1 to get to screen #23; record power cycle value.</li> <li>5. Press F4 to return to normal operation; monitor meter until problem returns.</li> <li>6. Return to screen #23 to see if power cycles have increased; microprocessor is resetting due to EMI electrical noise entering the meter.</li> <li>7. Check Power input and output cables grounding and routing.</li> </ol>         |
| Flow measurement is erratic or fluctuating | <ol style="list-style-type: none"> <li>1. Very turbulent flow</li> <li>2. Sensor dirty</li> <li>3. Sensor broken</li> <li>4. Probe not mounted securely</li> <li>5. Malfunction in flow meter</li> <li>6. Meter installed incorrectly</li> </ol> | <ol style="list-style-type: none"> <li>1. Increase dampening (see filter settings in "Flow Parameters" on p. 58)</li> <li>2. Clean sensor (Refer to Maintenance section, p. 89)</li> <li>3. Return flow meter to Sierra Instruments for repair (Refer to p. 104 for shipping instructions)</li> <li>4. Remount probe (see Installation section, p. 23); must be mounted securely without vibration. If vibration persists, choose a new mounting location without vibration.</li> <li>5. Return flow meter to Sierra Instruments for repair (Refer to p. 104 for shipping instructions)</li> <li>6. Re-install meter according to instructions (Refer to installation section, p. 23)</li> </ol> |

| Problem                    | Possible Cause(s)  | Action(s)  |
|----------------------------|--|--|
| Display Error              | <ol style="list-style-type: none"> <li>1. Loose or damaged ribbon cable</li> <li>2. Damaged electronics</li> <li>3. Ambient temperature</li> </ol> | <ol style="list-style-type: none"> <li>1. Visual inspection.</li> <li>2. Return the meter or display for repair.</li> <li>3. Operate meter between -20 to 70°C</li> </ol>  |
| Flow measurement seems low | <ol style="list-style-type: none"> <li>1. Probe not oriented properly</li> <li>2. Sensor dirty</li> </ol>  | <ol style="list-style-type: none"> <li>1. Orient probe per installation sections: Insertion (p. 29)</li> <li>2. Clean sensor (p. 89)</li> </ol>  |
| Unit will not power-up     | <ol style="list-style-type: none"> <li>1. No power input</li> <li>2. Bad fuse</li> <li>3. Bad Power supply</li> </ol>                              | <ol style="list-style-type: none"> <li>1. Check fuse (F1) located next to TS1 on main board.</li> <li>2. Check for correct power supply voltage at TS1 on main board.</li> </ol> <p>If fuse is OK and unit still won't power up, call Sierra Instruments for additional assistance</p> |

**Troubleshooting TM-Cal™**

If the TM100 Meter fails a TM-Cal™ Calibration Validation test, there are a few reasons that could be the cause:

1. Flow rate in the pipe:
  - Run the test again under a higher flow rate if possible.
2. The sensor may be dirty or damaged:
  - Visually inspect the meter for damage. If damage is found, meter may need to be serviced. Contact Sierra Instruments Technical Assistance at [techsupport@sierrainstruments.com](mailto:techsupport@sierrainstruments.com) for more information.
  - Try cleaning the sensor and try the test again under flow conditions.
3. If the meter fails again, contact Sierra Instruments Technical Assistance at 831-373-0200 for more information.

## Installation Problems

The following is a summary listing of problems that may be encountered with the installation of the TM100 Thermal Mass Flow Meter.

1. Improper wiring connections.  
Refer to Figures 3.1 to 3.11 and "Wiring Precautions" in Wiring section (p. 35) for further guidance.

2. Inadequate power source.

The TM100 requires 12 to 24VDC at to 6 Watts to operate. A 20 Watt power supply is recommended for powering the TM100 to ensure it operates properly under all temperature ventilation, and power on conditions. If the voltage supplied at the input terminals of the TM100 is not within the range of 10VDC to 30VDC, a variety of problems can occur including a dim display, inaccurate flow readings or faulty 4-20mA, pulse and communication interface.

3. Flow measurement seems inaccurate.

- Check to ensure that the flow meter is installed so that the Flow Direction Indicator is pointing in the direction of flow. Refer to Figure 2.6 (p. 29). If not, change orientation of meter.
- Check that the insertion depth of the sensor/probe is correct. The end of the probe should be adjusted as per Figure 2.5 (p. 26).
- Ensure that there are a minimum of fifteen diameters of straight pipe upstream of the sensor and ten diameters downstream. If complex flow disturbances are upstream of the sensor, extension of the straight pipe may be required to ensure accurate flow measurement. Contact Sierra Instruments for assistance.
- Ensure that pipe inside diameter in the meter matches data on the Sierra Instruments Calibration Certificate. The pipe inside diameter is programmed into the flow meter through the front panel (see Flow Parameters, p. 58).

4. Erratic flow reading (especially a flow reading spiking high).

This may be a symptom of moisture in the flow stream. Sierra Instruments flow meters are designed to work in relatively dry gas applications only. Contact Sierra Instruments to discuss resolutions to this problem.

5. Flow meter is not responding to flow.

- Check to ensure adequate power is supplied to the flow meter. If things appear to be correct, perform this functional test before calling Sierra Instruments. Carefully remove the probe and sensor from the pipe. For those flow meters with a display - and if the display is reading zero - blow on the sensor to see if a response occurs. If nothing happens, take a damp rag or sponge and place it in contact with the sensor. A reading should occur. Contact Sierra Instruments Customer Service with this information.

6. Display and/or 4-20mA signal reading above zero flow when no flow is occurring in the pipe. If the reading is less than 5% of full scale, it is likely this is a normal condition caused by convection flow created by the heated sensor. It does not mean that the zero of the instrument is improperly set. The Sierra Instruments sensor is extremely sensitive to gas flow and can even read the small flow caused by convection. If this is an unacceptable condition, please contact Sierra Instruments Customer Service for alternatives.



**Alarm Codes**

| Alarm Code | Reason                        | Action  |
|------------|-------------------------------|---|
| 13         | Flow rate above high limits   | Refer to the FLOW MENU 2 section on p. 58 of this Manual to verify limit is within range. Check ALM = HiFloAlm under PRM.   |
| 14         | Flow rate below low limits    | Refer to the FLOW MENU 2 section on p. 58 of this Manual to verify limit is within range. Check ALM = LoFloAlm under PRM.   |
| 15         | Temperature above high limits | Refer to the FLOW MENU 2 section on p. 58 of this Manual to verify limit is within range. Check ALM=HiTempAlm under PRM.  |
| 16         | Temperature below low limits  | Refer to the FLOW MENU 2 section on p. 58 of this Manual to verify limit is within range. Check ALM = LoTempAlm   |
| 22         | Sensor out of range           | Check the CSV voltage in ENG menu of the Engineering Screens, refer to page 15. It should be approximately 0.04 volts when FT1 is measuring no flow and up to 0.25 volts at high flow. Verify that parameters in FT1 are set correctly. If FT1 View is available, check parameter settings in Configuration page. If using FT1 front panel, check parameters in UNIT menu of FLOW MENU 1 and PRM menu of FLOW MENU 2, refer to pages 10-11. |
| 23         | Gas mix error                 | Gas mix must equal 100%.  |
| 24         | Check settings                | One or more internal settings are corrupted or out of spec. Contact Sierra Instruments Service for instructions to verify settings.   |
| 25         | Simulation mode               | Meter is in Simulation Mode. Refer to the FLOW MENU 1 section on p. 60 of this Manual. Use the SIM Section under Diagnostics to return to normal operation.   |
| 26         | Pulse/alarm output over range | Refer to the DIGITAL OUTPUT MENU on p. 12 of this Manual. Verify the Pulse/alarm Output settings are within limits.   |
| 32         | 4-20mA is out of range        | Refer to the MAIN MENU on p. 11 of this Manual. Use the Set I/O section to verify range limits.   |
| 34         | Busy                          | Meter is recalculating new parameters.  |
| 36         | Database CRC Error            | Refer to the Reset CRC section on p. 63 of this manual. Verify the programmed values are verified and corrected before clearing the error. Contact Sierra Instruments Service Department for possible causes.   |
| 38         | CSV Volt Error                | The CSV Voltage is out of the acceptable range. This may be a result of failed electronics, parameters, or sensor connections. Refer to action of Alarm Code 22.  |
| 39         | VFLO Volt Error               | The VFLO Voltage is out of the acceptable range. This may be a result of failed electronics, parameters, or sensor connections. Refer to action of Alarm Code 22.   |
| 40         | TSV Volt Error                | The TSV Voltage is out of the acceptable range. This may be a result of failed electronics, parameters, or sensor connections. Refer to action of Alarm Code 22.  |

**Alarm Codes** continued

|    |                                  |  |
|----|----------------------------------|--|
| 41 | VTEMP Volt Error                 | The VTEMP Voltage is out of the acceptable range. This may be a result of failed electronics, parameters, or sensor connections. Refer to action of Alarm Code 22.   |
| 42 | Delta T Error                    | The Delta T error between the sensor elements is too large. This may be a result of failed electronics, parameters, or sensor connections. Refer to action of Alarm Code 22.   |
| 43 | Invalid Board Calibration Values | The board calibration values do not match the values saved in the backup. This is the result of data corruption. The best course of action is to perform a "Restore Database" within the meter menus - this will restore the meter to its factory settings and calibrations. |
| 46 | TEMP Input Error                 | This may be a result of failed electronics, parameters, or sensor connections. Refer to action of Alarm Code 22. Focus on Yellow and Blue wires.   |
| 47 | TSV Input Error                  | This may be a result of failed electronics, parameters, or sensor connections. Refer to action of Alarm Code 22. Focus on Yellow and Blue wires.   |
| 48 | CSV Input Error                  | This may be a result of failed electronics, parameters, or sensor connections. Refer to action of Alarm Code 22. Focus on Red and White wires.   |
| 49 | FLO Input Error                  | This may be a result of failed electronics, parameters, or sensor connections. Refer to action of Alarm Code 22. Focus on Red and White wires.   |
| 53 | ADC Temp Below Spec              | This is the result of low temperatures inside the meter enclosure. Be sure to keep the meter within the specification.   |
| 54 | ADC Temp Above Spec              | This is the result of high temperatures inside the meter enclosure. Be sure to keep the meter within the specification.  |
| 55 | ADC NOREF                        | This is a result of failed electronics. Contact support for further assistance.  |

## Specifications

### Performance Specs

#### Flow Accuracy:

Air and Nitrogen (N<sub>2</sub>):  $\pm 1.0\%$  of reading plus  $\pm 0.2\%$  of full scale

Other Gases:  $\pm 1.5\%$  of reading plus  $\pm 0.5\%$  of full scale

Accuracy specification applies to customer's selected flow range

Maximum range: 15 to 25,000 SFPM (0.07 to 118 NMPS)

Minimum range: 15 to 500 SFPM (0.07 to 2.4 NMPS)

Straight, unobstructed pipe requirement

Insertion Meters: 15 diameters upstream; 10 downstream

Inline Meters: 8 diameters upstream; 4 downstream

Insertion Meters with Flowtrak: 5 diameters upstream; 5 downstream

Flow Repeatability:  $\pm 0.2\%$  of full scale

Flow Response Time: 0.8 seconds (one time constant)

Temperature Accuracy:  $\pm 1^\circ\text{F}$  ( $\pm 0.6^\circ\text{C}$ )

#### Calibration:

Factory Calibration to NIST traceable standards

TM-Cal™: In-situ, operator-initiated calibration validation

### Operating Specs

Mix up to five different gas mixes from the available list. Gas-Mix™ Gas Selections:

Air, Argon (Ar), Butane (C<sub>4</sub>H<sub>10</sub>), Carbon Dioxide (CO<sub>2</sub>), Ethane (C<sub>2</sub>H<sub>6</sub>), Helium (He),

Hydrogen (H<sub>2</sub>), Methane (CH<sub>4</sub>), Natural Gas (NAESB Mix), Nitrogen (N<sub>2</sub>), Oxygen (O<sub>2</sub>),

Propane (C<sub>3</sub>H<sub>8</sub>)

Units of Measurement (field selectable):

SCFM, SCFH, NM<sup>3</sup>/M, NM<sup>3</sup>/H, NM<sup>3</sup>/D, NLPS, NLPM, NLPH, MCFD, MSCFD, SCFD, MMSCFD, MMSCFM, SM<sup>3</sup>/D, SM<sup>3</sup>/H, SM<sup>3</sup>/M, LB/S, LB/M, LB/H, LB/D, KG/S, KG/M, KG/H, SLPM, MT/H

Gas Pressure (maximum at 100° F):

Insertion Meters: 740 psig (51.02 barg)

316 SS inline meter with NPT ends: 500 psig (34.47 barg)

316 SS inline meter with 150 lb. flanges: 230 psig (15.86 barg)

Carbon steel inline meter with NPT ends: 500 psig (34.47 barg)

Carbon steel inline meter with 150 lb. flanges: 285 psig (19.65 barg)

 **NOTE!** The EU Pressure Equipment Directive (PED) requires that the minimum ambient and fluid temperature rating for carbon steel flow bodies not be below  $-29^\circ\text{C}$ .

Retractor Assembly: 150 psig (10.34 barg)

Check with factory for higher pressure options.

**NOTE!** When teflon ferrule option ordered, gas pressure is 60psig (4.1 barg) maximum

**NOTE!** The EU Pressure Equipment Directive (PED) requires that the minimum ambient and fluid temperature rating for carbon steel flow bodies not be below  $-29^\circ\text{C}$ .

**Operating Specs (cont'd)**

Temperature:

DigiSense™ Sensor: -40°F to 250°F (-40°C to 121°C)

Enclosure: -40°F to 158°F (-40°C to 70°C)\*

**\*NOTE!** Display dims below -4°F (-20°C), function returns once temperature rises again.

Relative Humidity: 90% RH maximum; non-condensing

**NOTE!** Condensing liquids contacting the sensor can cause erratic flow indication.

Flow Velocity Range:

15 to 25,000 SFPM (0.07 to 118 NMPS)

Turndown: up to 1000:1; 100:1 typical

| Maximum Flow Ranges for TM100 Insertion Flow Meters |          |          |                     |
|---|----------|----------|---------------------|
| Pipe Diameter                                       | SCFM     | MSCFD    | NM <sup>3</sup> /hr |
| 1.5" (40mm)   | 0-354    | 0-510    | 0-558               |
| 2" (50mm)   | 0-583    | 0-840    | 0-920               |
| 2.5" (63mm)   | 0-830    | 0-1,310  | 0-1,200             |
| 3" (80mm)   | 0-1,280  | 0-1,840  | 0-2,020             |
| 4" (100mm)  | 0-2,210  | 0-3,180  | 0-3,480             |
| 6" (150mm)  | 0-5,010  | 0-7,210  | 0-7,910             |
| 8" (200mm)  | 0-8,680  | 0-12,500 | 0-13,700            |
| 10" (250mm)   | 0-13,600 | 0-19,600 | 0-21,450            |
| 12" (300mm)   | 0-19,400 | 0-27,900 | 0-30,600            |

**NOTE!** To determine if the TM100 will operate accurately in other pipe sizes, divide the maximum flow rate by the pipe area. The application is acceptable if the resulting velocity is within the velocity range above.

| Maximum Flow Ranges for TM100 Inline Flow Meters |         |         |                     |
|--|---------|---------|---------------------|
| Size   | SCFM    | MSCFD   | NM <sup>3</sup> /hr |
| 0.75"  | 0-93    | 0-134   | 0-146               |
| 1"   | 0-150   | 0-216   | 0-237               |
| 1.25"  | 0-260   | 0-374   | 0-410               |
| 1.5"   | 0-354   | 0-510   | 0-558               |
| 2"   | 0-583   | 0-840   | 0-920               |
| 2.5"   | 0-830   | 0-1,310 | 0-1,200             |
| 3"   | 0-1,280 | 0-1,840 | 0-2,020             |
| 4"   | 0-2,210 | 0-3,180 | 0-3,480             |
| 6"   | 0-2,500 | 0-3,600 | 0-3,950             |

**NOTE!** Standard conditions of air at 70°F and one atmosphere. Consult factory for other gases and for flow ranges above those listed. Inline meters above 2,500 SCFM (3,950 NM<sup>3</sup>/H) air may require third party calibration. Contact Sierra Instruments.

**Operating Specs (cont'd)**

Input Power: 12 to 24VDC, 6 watts

- Full Input Power Range: 10 to 30VDC.
- A 20 Watt or greater power supply is recommended to power the TM100.
- Class I Equipment (Electrical Grounding Required for Safety).
- Installation (Over-voltage) Category II for transient over-voltages.

**Outputs:**

Channel 1:

- Standard isolated 4-20mA output configured to indicate flow; fault indication per NAMUR NE43.
- The 4-20mA load resistance must be 125 ohms or less when operating on 12 volt power and 600 ohms or less on 24 volt power.
- HART communication option

Channel 2:

TM100 can be ordered with either the pulse output or serial communication option.

- Pulse option: Isolated open collector output rated for 5 to 24VDC, 20mA maximum load, 0 to 100Hz (the pulse output can be configured to either transmit a 0 to 100Hz signal proportional to flow rate or an on/off alarm).
- Serial communication option: Isolated Modbus RTU (RS485) or BACnet MS/TP (RS485).

USB Communication:

- Isolated USB 2.0 for interfacing with a laptop or computer is standard.
- TM100-View™: A free PC-based software tool that provides complete configuration, remote process monitoring, and data logging functions through USB communication.

4-20mA and Loop Verification:

Simulation mode used to align 4-20mA output with the input to customer's PLC/DCS.

**Physical Specs**

Probe diameter: 3/4"

Sensor material:

316 stainless steel

Enclosure:

NEMA 4X (IP67), aluminum, dual 3/4" FNPT conduit entries.

Flow Meter Installation:

A 3/4" MNPT compression fitting is provided with the TM100 to connect with a customer supplied 3/4" female branch outlet welded to the pipe. Extra 3/4" and 1" MNPT compression fittings are an ordering option from Sierra Instruments.

## Agency Approvals

CE: Approved

EMC Directive; 2014/30/EU

Electrical Equipment for Measurement, Control and Lab Use: EN61326-1:2013

Pressure Equipment Directive: 2014/68/EU

Weld Testing: EN ISO 15614-1 and EN ISO 9606-1, ASME B31.3

FM (FM21US0123X) and FMc (FM21CA0089X): Approved

Class I, Division 1, Groups B,C,D;

Class II, Division 1, Groups E,F,G;

Class III, Division 1; T4, Ta = - 40°C to +70°C;

Class 1, Zone 1, AEx/Ex db IIB + H2 T4 Gb; Ta= -40°C to +70°C; Type 4X, IP66/67

ATEX (FM23ATEX0041X): Approved

II 2 G Ex db IIB + H2 T4 Gb Ta = - 40°C to +70°C; IP66/67

II 2 D Ex tb IIIC T135°C Db Ta = - 40°C to +70°C; IP66/67

IECEX (IECEX FMG 23.0019X): Approved

Ex db IIB + H2 T4 Gb Ta = - 40°C to +70°C; IP66/67

Ex tb IIIC T135°C Db Ta = - 40°C to +70°C; IP66/67

ATEX and IECEX Standards:

EN IEC 60079-0                    IEC 60079-0

EN 60079-1                        IEC 60079-1

EN 60079-31                      IEC 60079-31

EN 60529 +A1 +A2                IEC 60529

### Specific Conditions of Use:

1. The flameproof joints of the equipment are not intended to be repaired. Consult the manufacturer if dimensional information on the flameproof joints is necessary.
2. Refer to the manufacturer's instructions to reduce the potential of an electrostatic charging hazard on the equipment enclosure.

Fig. 7.1: TM100 Insertion Meter with Retractor Dimensions  
 Measurements shown in inches (millimeters).

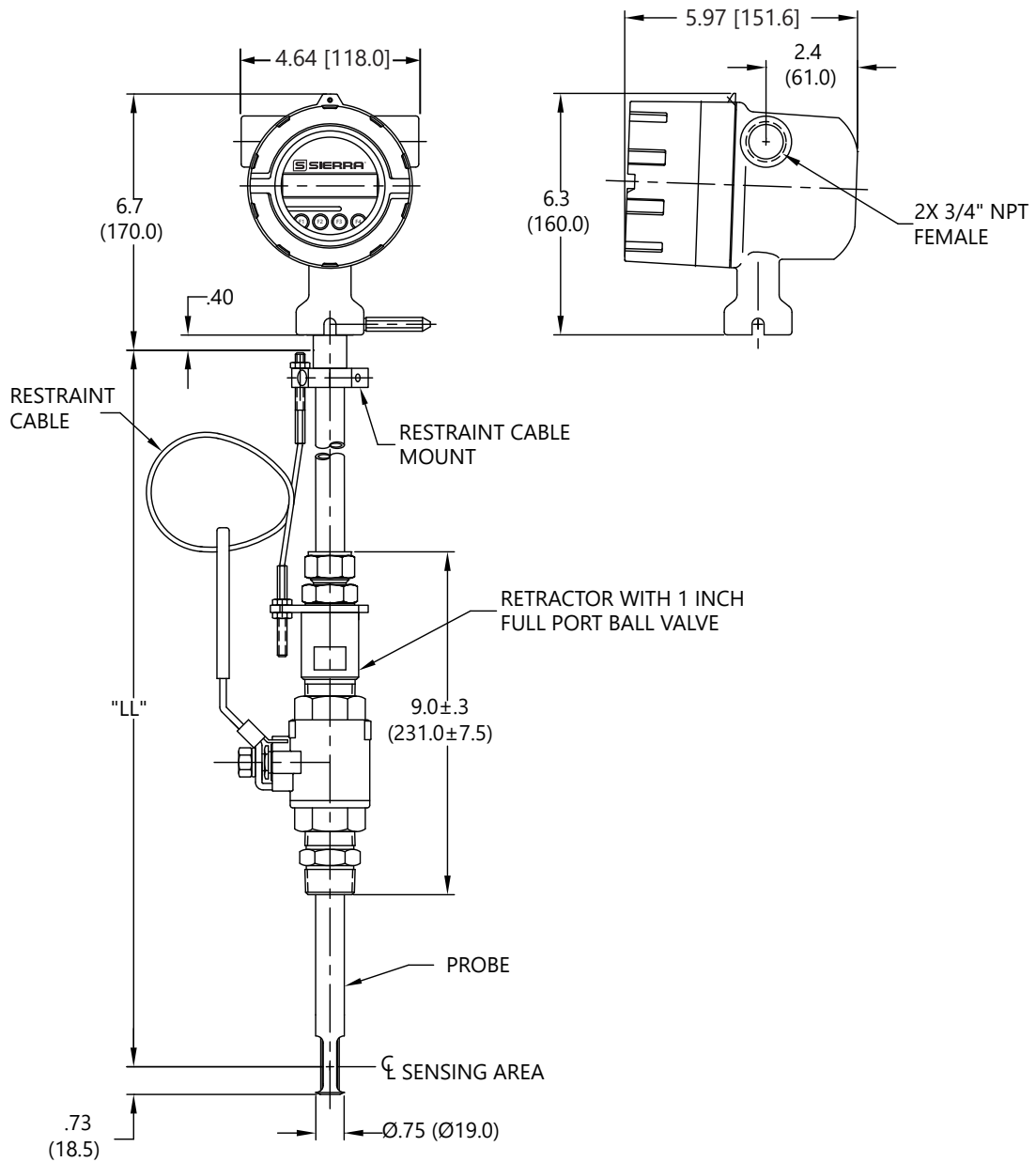

Table 7.1: TM100 Insertion Meter with 316 stainless steel probe

| Probe Size   | Probe Size | Dimension "LL" ± .10   |
|--------------|------------|------------------------|
| [model code] | [inches]   | [inches / millimeters] |
| 15R          | 15"        | 15.0" (381mm)          |
| 18R          | 18"        | 18.0" (457mm)          |
| 24R          | 24"        | 24.0" (610mm)          |
| 30R          | 30"        | 30.0" (762mm)          |
| 36R          | 36"        | 36.0" (914mm)          |

Fig. 7.2: TM100 Insertion Meter Dimensions

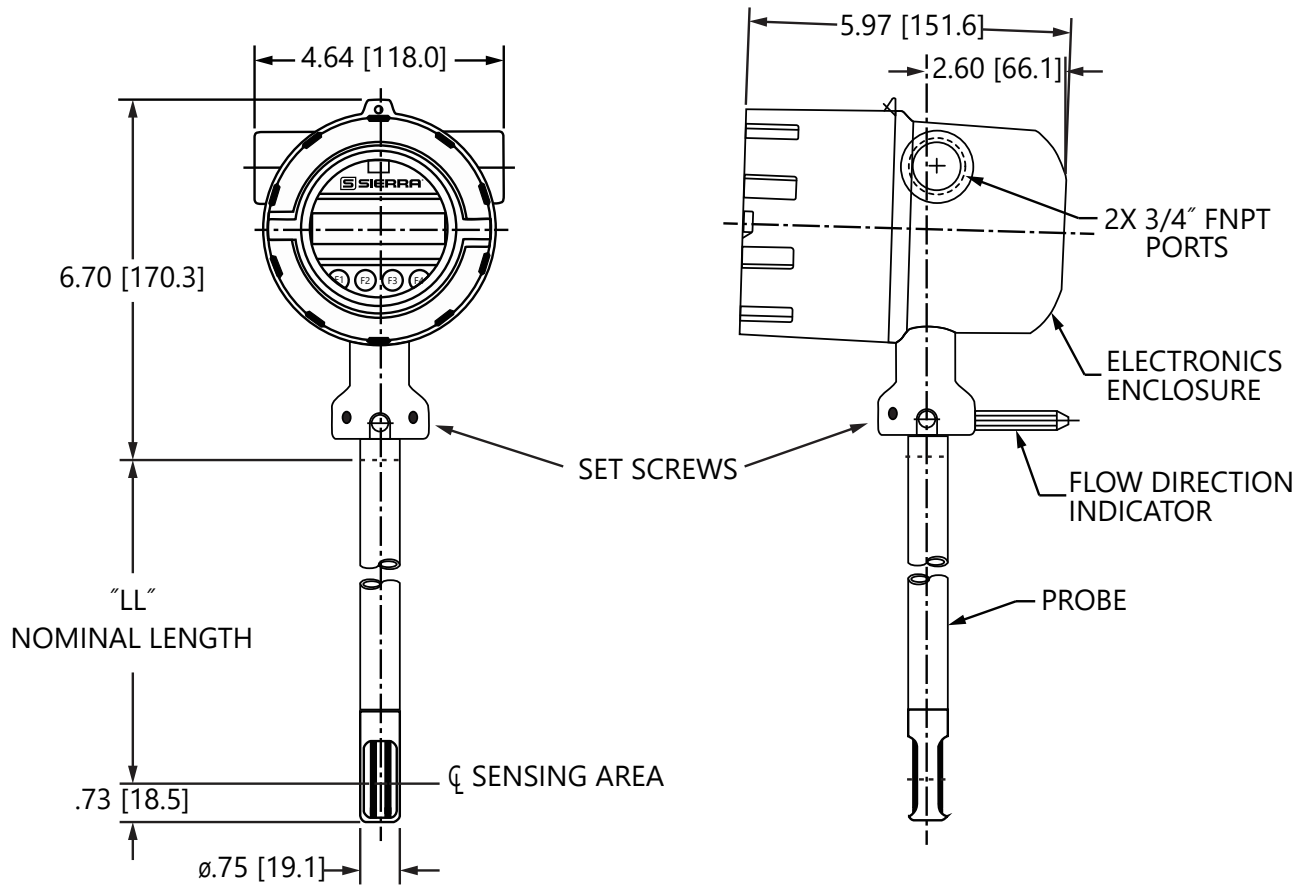

Table 7.2: TM100 Insertion Meter with 316 stainless steel probe

| Probe Size<br>[model code] | Probe Size<br>[inches] | Dimension "LL" $\pm$ .10<br>[inches / millimeters] |
|----------------------------|------------------------|--|
| 06I                        | 6"                     | 6.0" (152mm)                                       |
| 09I                        | 9"                     | 9.0" (229mm)                                       |
| 12I                        | 12"                    | 12.0" (305mm)                                      |
| 15I                        | 15"                    | 15.0" (381mm)                                      |
| 18I                        | 18"                    | 18.0" (457mm)                                      |
| 24I                        | 24"                    | 24.0" (610mm)                                      |
| 30I                        | 30"                    | 30.0" (762mm)                                      |
| 36I                        | 36"                    | 36.0" (914mm)                                      |



Fig. 7.3: TM100 Inline Meter with Flow Body NPT End Connections Dimensions

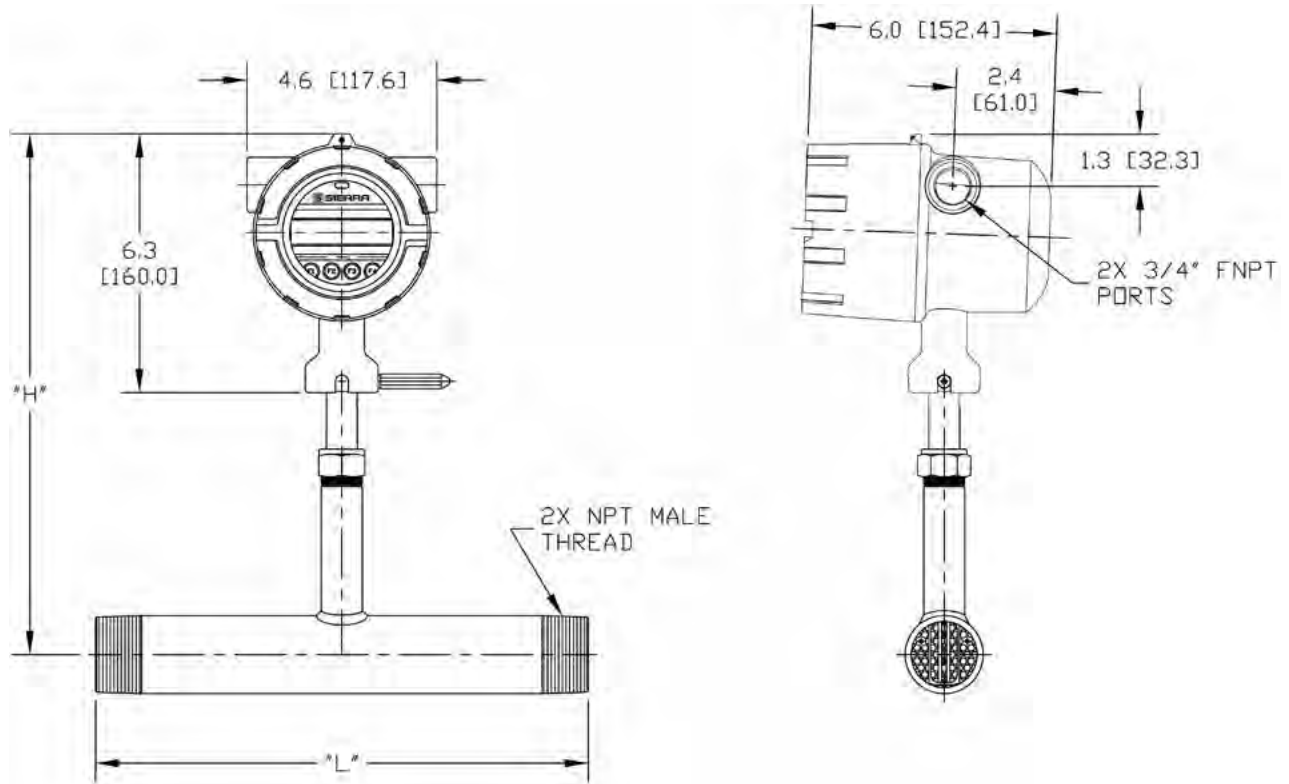

Table 7.3: TM100 Inline Meter with Flow Body and NPT End Connections

| Body Size    | Body Size | Dimension "L" +/- .10 | Dimension "H" +/- .25  |
|--------------|-----------|-----------------------|------------------------|
| [model code] | [inches]  | [inches]              | [inches / millimeters] |
| 075P *       | 0.75"     | 12"                   | 10.7" (271.8mm)        |
| 10P *        | 1.00"     | 12"                   | 10.7" (271.8mm)        |
| 125P *       | 1.25"     | 12"                   | 10.7" (271.8mm)        |
| 15P *        | 1.50"     | 12"                   | 12.7" (322.6mm)        |
| 20P **       | 2.00"     | 12"                   | 12.7" (322.6mm)        |
| 25P **       | 2.25"     | 18"                   | 12.7" (322.6mm)        |
| 30P **       | 3.00"     | 18"                   | 12.7" (322.6mm)        |

\*Available in 316 stainless steel only

\*\*Available in 316 stainless steel or A106 Grade B Carbon steel pipe

Fig. 7.4: TM100 Inline Meter with Body 150 lb RF Flange End Connections Dimensions

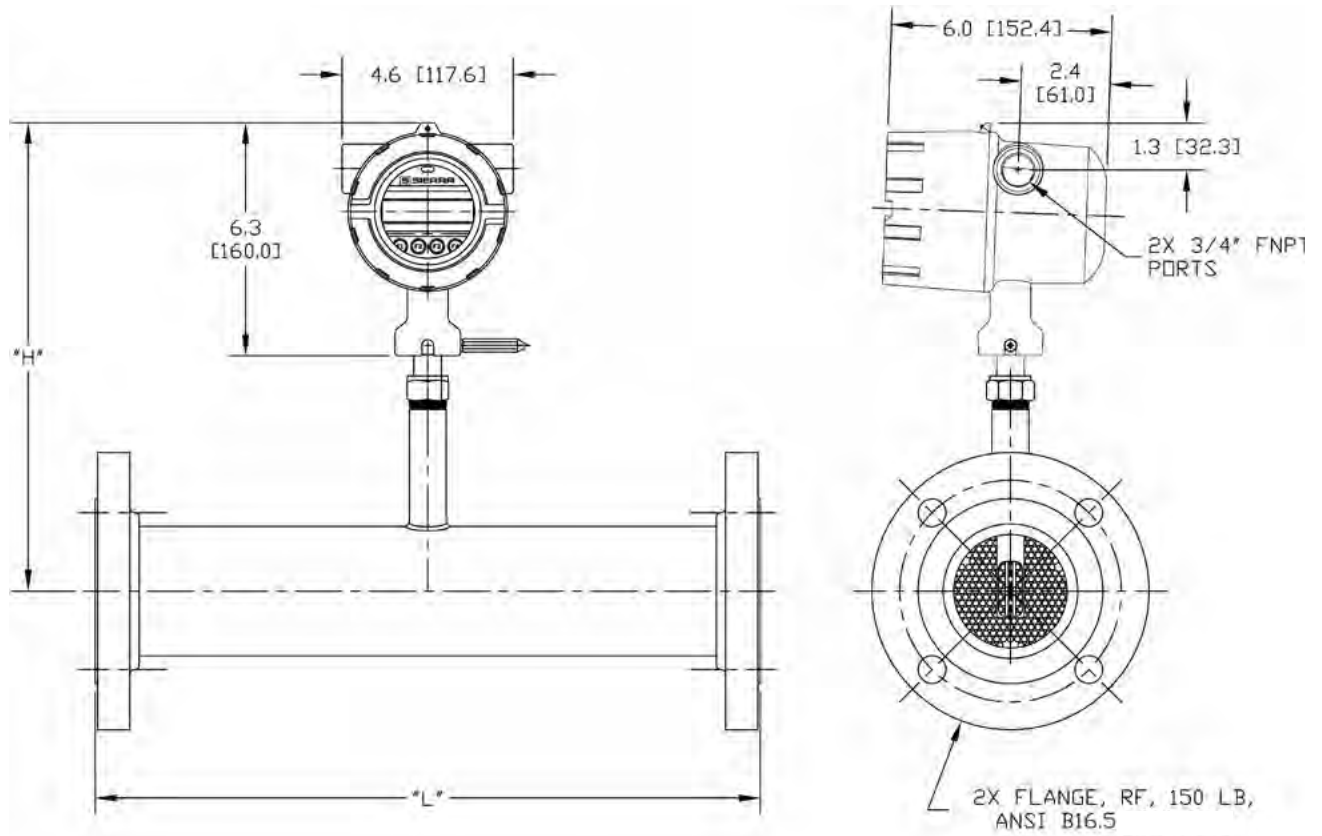

Table 7.4: TM100 Inline Meter with Flow Body and 150 lb RF Flange End Connections Dimensions

| Body Size    | Body Size | Dimension "L" +/- .10 | Dimension "H" +/- .25  |
|--------------|-----------|-----------------------|------------------------|
| [model code] | [inches]  | [inches]              | [inches / millimeters] |
| 075F *       | 0.75"     | 12"                   | 10.7" (271.8mm)        |
| 10F *        | 1.00"     | 12"                   | 10.7" (271.8mm)        |
| 125F *       | 1.25"     | 12"                   | 10.7" (271.8mm)        |
| 15F *        | 1.50"     | 12"                   | 12.7" (322.6mm)        |
| 20F **       | 2.00"     | 12"                   | 12.7" (322.6mm)        |
| 25F **       | 2.50"     | 18"                   | 12.7" (322.6mm)        |
| 30F **       | 3.00"     | 18"                   | 12.7" (322.6mm)        |
| 40F **       | 4.00"     | 18"                   | 12.7" (322.6mm)        |
| 60F **       | 6.00"     | 24"                   | 12.7" (322.6mm)        |

\*Available in 316 stainless steel only

\*\*Available in 316 stainless steel or A106 Grade B Carbon steel pipe

## Warranty Policy

### Limited Warranty Policy- Register Online

All Sierra products are warranted to be free from defects in material and workmanship and will be repaired or replaced at no charge to Buyer, provided return or rejection of product is made within a reasonable period but no longer than one (1) year for calibration and non-calibration defects, from date of delivery. To assure warranty service, customers must register their products online on Sierra's website. Online registration of all of your Sierra products is required for our warranty process. Register now at [www.sierrainstruments.com/register](http://www.sierrainstruments.com/register).

## Returning Equipment to Factory

### Factory Calibration—All Models

Sierra Instruments maintains a fully-equipped calibration laboratory. All measuring and test equipment used in the calibration of Sierra transducers are traceable to NIST Standards. Sierra is ISO-9001 registered and conforms to the requirements of ANSI/NCSL-Z540 and ISO/IEC Guide 25.

### Instructions for Returning Your Instrument for Service

The following information will help you return your instrument to Sierra Instruments' Factory Service Center and will ensure that your order is processed promptly. Prices may vary depending on the flow range, type of gas and operating pressure of your unit. To request detailed pricing, contact your local Sierra Instruments distributor or contact one of our offices directly.

### Please follow these easy steps to return your instrument for factory service:

1. To obtain a Return Materials Authorization (RMA) number from the Sierra Instruments to <http://www.sierrainstruments.com/rma/new.php> to create a Sierra Account.
2. Once you have created an account, click on the Submit New RMA tab and fill in the RMA form and follow the instructions. You will receive an email confirmation once you have submitted your RMA.
3. Print a copy of the RMA (that now includes RMA #) and send a copy of the RMA form along with your meter back to the factory.

If you require service beyond calibration, but do not know which service(s) will be required, describe the symptoms as accurately as possible on the RMA form.

Pack your instrument carefully. Use the original packaging and foam or bubble wrap (packing peanuts NOT recommended) and include a copy of the RMA form (complete with Sierra supplied RMA number) with the unit(s).

Ship the unit(s) to the following address:

**Sierra Instruments, Inc.**  
**Attention: Factory Service Center**  
**5 Harris Court, Building L**  
**Monterey, CA 93940 USA**  
**RE: RMA# (your number)**



## Glossary of Terms and Definitions

|                 |   |                    |                                      |
|-----------------|---|--------------------|--------------------------------------|
| AWG             | American Wire Gauge                               | NLPH               | Normal Liter per Hour                |
| Bara            | Bar absolute                                      | NLPM               | Normal Liter per Minute              |
| CTC             | Contact   | NM3                | Normal cubic Meter                   |
| CAL             | Calibration                                       | NM3/H              | Normal cubic Meter per Hour          |
| CHG             | Change  | NM3/M              | Normal cubic Meter per Minute        |
| COM             | Communication                                     | NPT                | National Pipe Thread                 |
| CSV             | Current Sense Voltage                             | PDA                | Personal hand held computer          |
| DC              | Direct Current                                    | PC                 | Personal Computer                    |
| DN              | Down  | P/U                | Pulse per Unit                       |
| DSP             | Display   | PIP A <sup>2</sup> | Pipe Area                            |
| ELP             | Elapsed time                                      | PLC                | Programmable Logic<br>Controller     |
| Feq             | Frequency   | PRM                | Parameters                           |
| Ft <sup>2</sup> | Square Feet                                       | PRS                | Pressure                             |
| I/O             | Input/Output                                      | PSIA               | Pounds per Square Inch<br>Absolute   |
| INP             | Input   | Pt                 | Point                                |
| LB              | Pound   | PSW                | Password                             |
| LB/D            | Pound per Day                                     | SIM                | Simulation                           |
| LB/H            | Pound per Hour                                    | SCF                | Standard Cubic Feet                  |
| LB/M            | Pound per Minute                                  | SCFM               | Standard Cubic Feet per<br>Minute    |
| LB/S            | Pound per Second                                  | SCFH               | Standard Cubic Feet per Hour         |
| LCD             | Liquid Crystal Display                            | SCFD               | Standard Cubic Feet per Day          |
| KG              | Kilogram  | SPC                | Special Control                      |
| KG/H            | Kilogram per Hour                                 | STP                | Standard Temperature and<br>Pressure |
| KG/M            | Kilogram per Minute                               | TMP                | Temperature                          |
| KG/S            | Kilogram per Second                               | TSI                | Internal Variable                    |
| M <sup>2</sup>  | Square Meter                                      | TSV                | Internal Variable                    |
| mmHG            | Pressure in millimeters of mercury                | UNT                | Unit                                 |
| MMSCFD          | Million Standard Cubic Feet per<br>Day            | U/P                | Unit per Pulse                       |
| MXFLO           | Maximum Flow                                      | 420                | 4-20mA output                        |
| NEMA            | National Electrical Manufactures<br>Association   |                    |                                      |
| NIST            | National Institute of Standards<br>and Technology |                    |                                      |
| NL              | Normal Liter                                      |                    |                                      |

## Index

- Access to Electronics, p. 35
- Alarm Codes, p. 97
- Alarm wiring, p. 41
- Analog 4-20mA output, p. 49
- Breakage or Damage of Probe, p. 88
- TM-Cal™, p. 64
- BACnet, p. 80
- Gas-Mix™, p. 66
- Dimension Details, p. 103
- Discrete output setting, p. 52
- Display Screens, p. 47
- Display Setup, p. 54
- Entering the programming mode, p. 48
- Filter value, p. 48
- Flow Meter Placement, p. 23
- Flow Units, p. 56
- Pulse/alarm Output, p. 51
- Fuse Replacement, p. 89
- Glossary, p. 110
- Installation,
  - Compression Fitting - Insertion, p. 35
  - Lateral Placement, p. 23
  - Mounting, p. 23
  - Orientation of Meter - Insertion, p. 29
- Introduction, p. 19
- Level 2 password, p. 55
- Local Display, p. 21
- Local Input Wiring, p. 37
- Mass Flow, p. 19
- Measurement Mode, p. 47
- Menu Tree,
  - TM-Cal™ Menu, p. 16
  - Gas-Mix™, p. 17
  - Digital Output, p. 12
  - Display Menu, p. 15
  - Engineering Display, p. 16
  - Main Menu, p. 11
  - Flow Menu 1, p. 13
  - Flow Menu 2, p. 14
- Mounting meter, p. 23
- Orientation of meter - Insertion type, p. 29
- Password
  - Level 1, p. 55
  - Level 2, p. 55
- Programming, p. 55
- Power Input Wiring, p. 37
- Preventative Maintenance, p. 89
- Product Description, p. 19
- Programming
  - Analog 4-20mA Output, p. 49
  - Alarm Output, p. 52
  - Changing values or strings, p. 48
  - Display Setup, p. 54
  - Flow Parameters, p. 58
  - Flow and maximum pulse/alarm, p. 52
  - Pulse/alarm Output, p. 51
  - Password, p. 55
  - Programming Mode, p. 48
  - Pulse-per-unit, p. 51
  - Reset CRC, p. 63
  - Selecting from a list, p. 48
  - Serial Communication, p. 53
  - Simulation, p. 63
  - Unit-per-pulse, p. 52
  - Unit settings, p. 56
  - Using the Local Display, p. 48
- Replacements Fuses, p. 89
- Return Procedure, p. 104
- Sensor Cleaning, p. 89
- Sensor Orientation, p. 29
- Simulation Mode, p. 63
- Theory of Operation, p. 19
- To program the display, p. 54
- Troubleshooting, p. 94
  - Alarm Codes, p. 97
  - General, p. 94
  - Installation Problems, p. 96
- USB Interface, p. 46
- Warranty, p. 106
- Wiring
  - Alarms, p. 40
  - Pulse/Alarm Outputs, p. 40
  - Grounding, p. 36
  - Input - Local, p. 37
  - Instructions, p. 35
  - Local meters, p. 37
  - Power Input, p. 37
  - Precautions, p. 36



Wiring



Definition of Terms



Troubleshooting Tips



**NOTE!** is used for Notes and Information



**WARNING!** is used to indicate a hazardous situation which, if not avoided, could result in death or serious injury.



**CAUTION!** is used to indicate a hazardous situation which, if not avoided, could result in minor or moderate injury.



Indicates compliance with the **WEEE Directive**. Please dispose of the product in accordance with local regulations and conventions.



Indicates compliance with the applicable European Union Directives for Safety and EMC (Electromagnetic Compatibility Directive 2014/30/EU).

**IP67**

Enclosure Protection Classification per IEC 60529: Protected against the ingress of dust and Immersion.