

Product Information NVS-041, -043, -046, -061, -063, -066, -081, -083, -086

FOOD

Level Sensor with M12 Thread Hygienic



Application/intended use

- Limit detection of aqueous and conductive media in vessels and pipes with minimum conductivity. The conductivity depends on the evaluation device: 1 $\mu\text{S}/\text{cm}$ when using external evaluation units, e.g. VNV series or ZNV-Z, and 10 $\mu\text{S}/\text{cm}$ when using the internal evaluation unit MNV-1C or MNV-M.

Application examples

- Limit detection of fluids in vessels (where the sensor is built in from the side) or pipes
- Full alarm in vessels and tanks where the sensor is built in from the top
- Empty alarm in vessels and tanks where the sensor is built in from the bottom
- Product monitoring in pipes
- Pump/dry-running protection
- Level control in tanks
- Overfill protection in dosing systems

Hygienic design/process connection

- Hygienic process connection with CLEANadapt
- Conforming to 3-A Sanitary Standard for versions with DIRECTadapt
- All wetted materials are FDA-conform
- Sensor completely made of stainless steel and PEEK, coating made of PFA
- Complete overview of process connections: see order code
- The Anderson-Negele CLEANadapt system offers a flow-optimized, hygienic and easily sterilizable installation solution for sensors.

Special features/advantages

- CIP/SIP cleaning up to 143 °C/120 minutes max.
- Defined position of the cable entry
- Available with or without an integrated level transmitter
- Different electrical connections available
- Rods may be shortened and twisted as needed
- Miniature edition, installation in pipes beginning at DN15 possible
- Fully molded to avoid condensation

Options/accessories

- High-temperature version available (with 100-mm spacer; for use in processes with constant temperatures of up to 140 °C)
- Fixed cable also available in other cable lengths

Selection of the right sensor type

- **Coating**
For foamy, adhesive (e.g. yoghurt) and/or wetting media (e.g. alkaline solutions), we suggest using a sensor with a coated rod.
Sensors with non-coated rods are only suitable for aqueous, non-adhesive and non-wetting media.
- **Temperature**
If a sensor **with an integrated level transmitter MNV** is needed, we suggest using the high-temperature version with a spacer if the medium temperature exceeds 60 °C (option H).

Authorizations



NVS-041



NVS-061



NVS-046



Specification of level sensor		
Process connection	crevice-free torque thread size	CLEANadapt build-in system, e.g. EMK-032 or EHG-.../M12 5...10 Nm M12 x 1.5
Material	connecting head rod insulating part coating	1.4301 1.4404 PEEK (FDA approval number 21CFR177.2414) PFA (FDA approval number 21CFR177.2440, 21CFR177.1550)
Surface quality		$R_a \leq 0.8 \mu\text{m}$ (wetted parts)
Weight		approx. 500 g
Rod length	NVS-041; -061; -081 NVS-043; -046; -063; -066; -083; -086	9 mm 200 mm (may be shortened to the requested length)
Operating pressure		max. 10 bar
Temperature ranges*	process NVS-04x process NVS-06x, NVS-08x cleaning ambient	0...140 °C 0...100 °C 143 °C/120 min -10...+60 °C
Electrical connection	cable gland plug connection fixed cable 2.5 m - with level transmitter - without level transmitter	M16x1.5 (PG) M12 plug, 1.4305 PVC 4 x 0.25 mm ² silicone 2 x 0.5 mm ²
Protection class	with M12 plug connection with cable connection	IP 69 K IP 67

*) When the MNV level module is integrated, please note the temperatures specified below in the technical data of the level transmitter.

Specification of MNV level transmitter (attention: differs from the basic unit)		
Temperature ranges	operation storage	-10...+60 °C (with NVS standard equipment) -10...+140 °C (with NVS high-temperature version) -20...+60 °C
Humidity	without condensation	0...95% r. H.
Power supply		18...36 V DC
Electrode E1	measuring voltage	1.5...2 VAC/300 Hz no DC signal
Selectable sensitivity	MNV-1C MNV-M	0,1 kΩ; 1 kΩ; 10 kΩ; 100 kΩ (via jumper) 0.2 kΩ; 2 kΩ; 20 kΩ (via control input voltage (Tri-State-Logic))
Output		PNP (active 50 mA, short-circuit-proof)
Delay	fixed	0.5 s
Switching function min/max selectable	MNV-1C MNV-M	via jumpers polarization of power supply

NVS-041

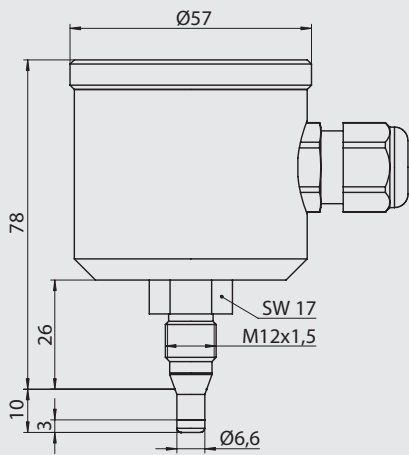

NVS-041 ... / H

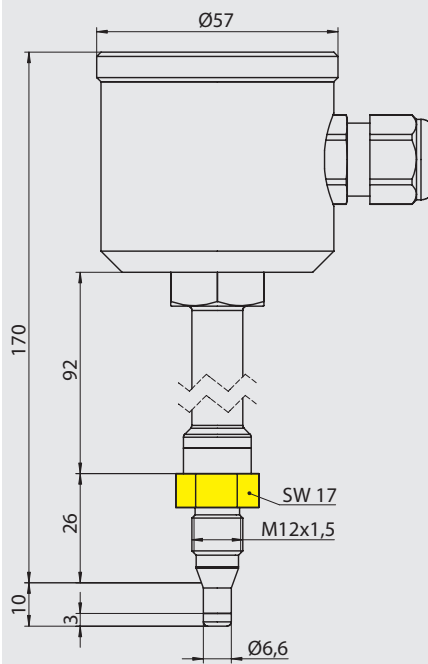

NVS-043

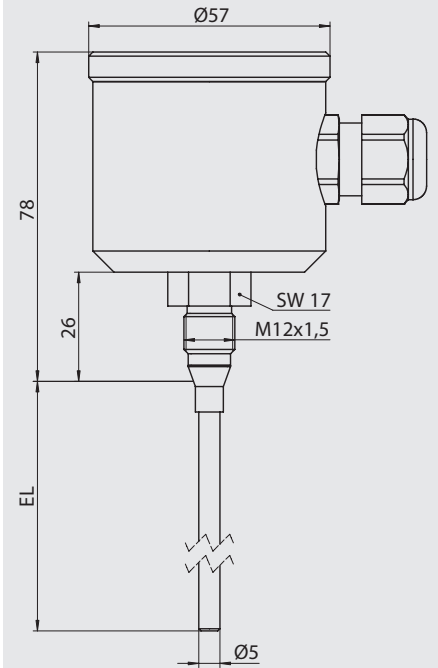

Advice for NVS-04x ... / H



Tighten the sensor only at the lower, marked in yellow spanner flat (BE = 17 mm)!

NVS-061

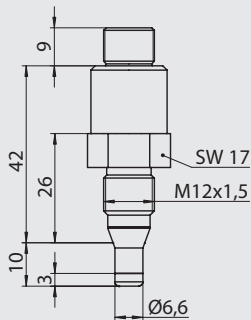

NVS-063 / M

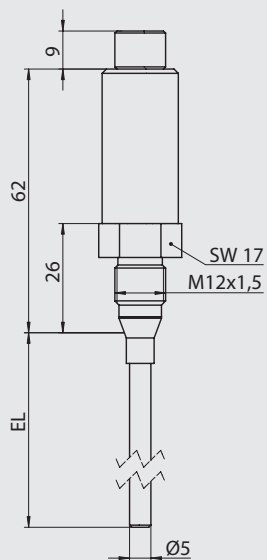

NVS-081

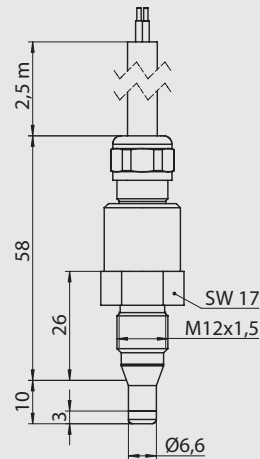

NVS-083 / M

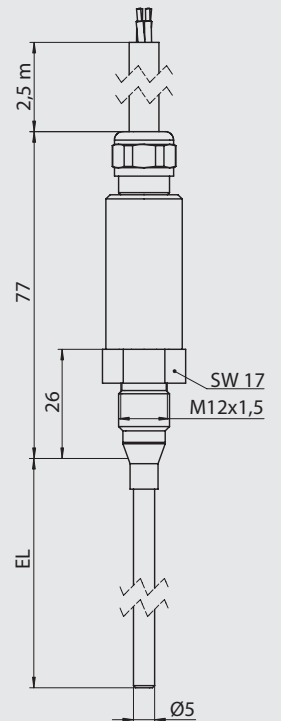

Electrical connection without level transmitter

With terminals

EO	rod (sensor)	
M	GND	

Electrical connection with MNV-1C, MNV-M transmitter

With clamps (with level transmitter MNV-1C)

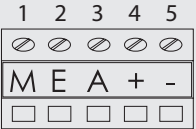
1	GND	
2	rod (sensor)	
3	active output	
4	+power supply	
5	-power supply	

With M12 plug

Configuration of the M12 plug

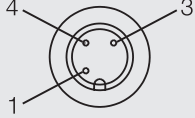
1 (brown)	not connected	
2		
3 (blue)	GND	
4 (black)	rod (sensor)	

With M12 plug (with level transmitter MNV-M)

Configuration of the M12 plug (full alarm)

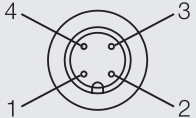
1 (brown)	+power supply	
2 (white)	control input sensitivity	
3 (blue)	-power supply	
4 (black)	active output	

With fixed cable

With PVC/silicone cable

brown	rod (sensor)	
blue	GND	

With Teflon cable (PTFE)

red	rod (sensor)
white	GND

With fixed cable (with level transmitter MNV-M)

With PVC cable (full alarm)

white	+power supply	
yellow	control input sensitivity	
brown	-power supply	
green	active output	

Notice:
silicone and/or Teflon cables (PTFE)
are not available in this version.

Instructions on the electrical connection with level transmitters MNV-1C, MNV-M



The sensitivity and the switching behavior of sensors with level transmitters may be configured using an electrical connection or a jumper. Please also take note of the figures on the next page.

Setting up the MNV-1C, MNV-M level transmitters



- Connect the supply voltage.
- Select the switching function (see "Configuration of the level transmitter").
- Select the minimum sensitivity (see "Configuration of the level transmitter").
- Wet the sensor with the least conductive medium.
- If the output switches, the selected sensitivity may be retained and calibration is finished. If the output does not switch, please continue as follows.
- Increase the sensitivity until the output switches. Once this happens, calibration is finished.

Switching state explanation

Full indicator: The output is active when immersed
Empty indicator: The output is active when not immersed

Level transmitter MNV-1C

- 1: LED sensor (lights up when the sensor is immersed, independent of the switching function)
- 2: Terminal block
- 3: Full/empty jumper
- 4: Sensitivity jumper

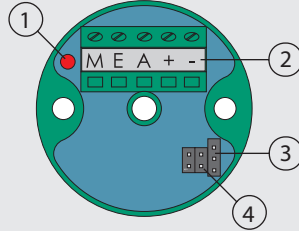

Configuration of the MNV-1C level transmitter

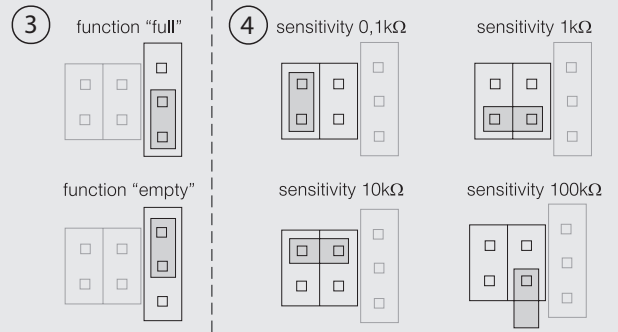

Standard setting on delivery
3: full
4: 10 kΩ

Configuration of the MNV-M level transmitter with NVS-061/M; NVS-063/M; NVS-066/M

Sensitivity

full alarm

empty alarm

0.2 kΩ

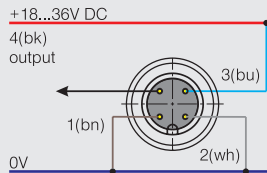
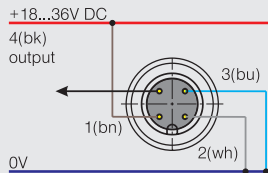

2 kΩ

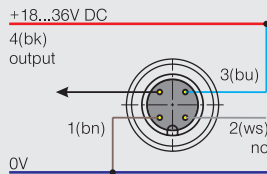
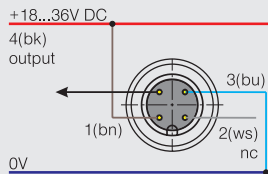

20 kΩ

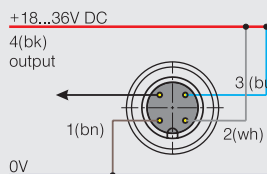
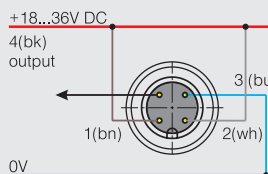

Configuration of the MNV level transmitter with NVS-081/M; NVS-083/M; NVS-086/M

Sensitivity

full alarm

empty alarm

0.2 kΩ

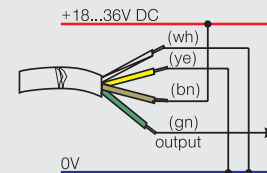
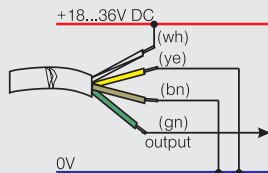

2 kΩ

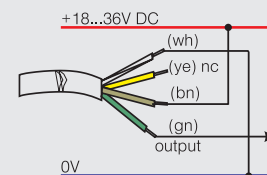
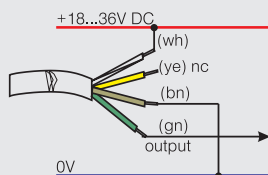

20 kΩ

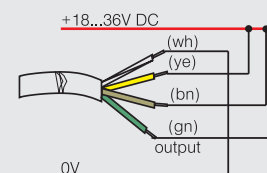
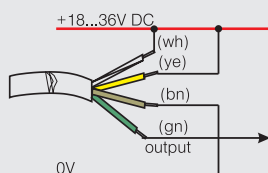

General installation



- If necessary, cut the rods to the required lengths. In doing so, ensure that the compound between the rod and the thread connector is not strained excessively. If using coated rods, do not damage the insulation of the rod part that remains on the sensor.
- Strip 5 mm of insulation off the tip of insulated rods (the length depends on the conductivity of the medium).
- Screw the sensor into the sleeve and connect as shown in the wiring diagrams. Do not damage the coating when you mount the sensor in the sleeve.

Mounting instructions



- Do not exceed the maximum torque when you screw in the sensor.
- To guarantee reliable operation of the measuring point, make sure you have a good electrical connection between the process connection thread of the sensor and the pipe or vessel wall.
- Do not use any kind of sealing tape, such as Teflon tape. Also follow the instructions in the CLEANadapt product information if necessary.
- If the stub sensor is used in pipes, ensure that the rod emerges from the liquid when the medium is drained. We suggest installing the sensor in vertical pipes.
- Tank and pipe walls must be made of metal.
- For mounting and removing the sensor, please use the wrench flats only. Do not use the connecting head.

Conditions for a measuring point according to 3-A Sanitary Standard 74-06



- The sensors NVS-041, -043, -046, -061, -063, -066, -081, -083, -086 comply with the 3-A standard.
- The sensors are designed for CIP/SIP cleaning up to a maximum temperature of 143 °C for 120 minutes.
- Only approved in combination with the CLEANadapt build-in system (EMZ, EMK, EHG with a pipe diameter > DN25, ISO 20 and 1", AMC and AMV adapters)
- When using the EMZ and EMK weld-in sleeves, the weld must comply with the requirements of the current 3-A Sanitary Standard.
- Mounting position: The mounting position, self-draining properties and the position of the leakage hole must be in accordance with the current 3-A Sanitary Standard.

Information on CLEANadapt process connections



Please find the complete overview of all adapters available as well as the respective technical data in the product information on CLEANadapt process adapters.

Selection of possible process connections

Process connection	Build-in system EHG (DIN 11850 series 2)	Weld-in sleeve	Weld-in ball	Collar sleeve	APV-Inline

Cleaning/maintenance

- When using a pressure washer, do not point the nozzle directly at the electrical connections.

Transport/storage

- No outdoor storage
- Store in an area that is dry and dust-free
- Do not expose to corrosive media
- Protect against solar radiation
- Avoid mechanical shock and vibration
- Storage temperature 0...40 °C
- Relative humidity max. 80%

Reshipment

- Sensors and process connection must be clean and must not be contaminated with hazardous media and/or heat-conductive paste. Note the cleaning information!
- To avoid damage of the equipment, use suitable transport packaging only.

Standards and guidelines

- Compliance with the applicable regulations and directives is mandatory.

Note on CE

- Applicable directives:
Electromagnetic Compatibility Directive 2014/30/EU
- Compliance with the applicable EU directives is identified by the CE label on the product.
- The operating company is responsible for complying with the guidelines applicable to the entire installation.

Disposal

- Electrical devices should not be disposed of with household trash. They must be recycled in accordance with national laws and regulations.
- Take the device directly to a specialized recycling company and do not use municipal collection points.

Order code

NVS-04 (connecting head diameter 55 mm with cable gland M16x1.5)
NVS-06 (connecting head diameter 18 mm with M12 plug)
NVS-08 (connecting head diameter 18 mm with fixed cable 2.5 m; other cable lengths: see at accessories)

Rod

1/00 (without coating, stub sensor EL = 9 mm, diameter 6.6 mm)
3/200 (without coating 200 mm, diameter 5 mm)
6/200 (coated 200 mm, diameter 5 mm)
3/[mm] special length without coating, diameter 5 mm (length in mm; max. 200 mm)
6/[mm] special length coated, diameter 5 mm (length in mm; max. 200 mm)

Evaluation unit

X (without)
M (integrated in connecting head; type-specific with MNV-1C or MNV-M)

High-temperature version

X (standard, only for sensors without evaluation unit and type-specific process temperatures (see technical data))
H (with spacer: recommended for evaluation unit and process temperatures > 60 °C)
ATTENTION: Please note the specifications regarding process temperature as given in the technical data.

Wire-break monitoring

(only possible with an external evaluation unit VNV-SD or VNV-W)
X (without)
D (with wire-break resistor)





NVS-04 6 / 200 / M / H / X

Information on external evaluation devices



Please find the complete overview of all external evaluation devices available as well as the respective technical data in the product information on evaluation electronics for conductive limit switches.

Selection of possible external evaluation electronics with relay or active output

Type	VNV-E	VND-D	ZNV-Z	VNV-V
				
	1 x level control	1 x level control 1 x level detection	2 x level detection	4 x level detection